

Miniature Gearheads

Harmonic Drive™ Gearheads
CSF Mini Series
CSF-2XH-F
CSF-2XH-J
CSF-1U

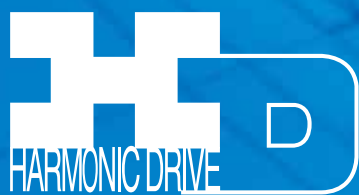

Total Motion Control

Harmonic Drive™ gear

Precision Gearing and Motion Control

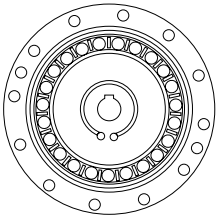

CSF MINI SERIES

Harmonic Drive™ precision gear is the next generation in precision motion control.

Harmonic Drive™ Precision Control Speed Reducers for compact models are available in this CSF Mini Series.

Future

Zero-Backlash, High Positional Accuracy, High Repeatability

The innovative design of Harmonic Drive™ precision gear allows consistently high performance over the life of the gear.

Compact, Lightweight, High Torque Capacity

Harmonic Drive LLC' patented "S" gear tooth profile achieves twice the torque, life and torsional stiffness as compared to gears of the same size by allowing up to 30% of the gear teeth to be engaged at all times.

Compact 4-Point Contact Ball Bearing Mounted In Main Shaft

A high performance 4-point contact output bearing supports the output flange/shaft. This bearing has excellent run-out characteristics and can support high radial, axial and moment loads.

Wide Range Of Gear Ratios And Input/Output Configurations In Each Size

Gear Ratios 30:1, 50:1, and 100:1 are available in each size. This allows servomotor and gearhead combinations to operate over a wide speed range. In addition, each size has 3 input/output shaft/flange configurations allowing convenient methods for attaching loads, motors, and pulleys.

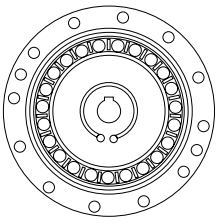

About Harmonic Drive™ Gear

Principle and Structure	04
Driving Configuration	05
Application Example	06
Ordering Information Model and Code	06
Rating Table	07
Definition of Ratings	07
Strength and Life	08
Selection Procedure	09
Selection Example	10

Unit Type CSF-mini

External Dimensions	11
Specification for Cross Roller Bearing	12
Output Bearing Ratings	13
Specifications of Output Bearings	14

Engineering Data

Efficiency	15
No Load Running Torque	17
Starting Torque and Backdriving Torque	19
Positioning Accuracy	19
Torsional Stiffness	20
Recommended Tolerance for Assembly	22
Performance Data for Input Bearing	23
Installation of Case Side	24
Tolerances for Assembly	25

Warranty and Safety

Warranty	25
Safety Guide	26

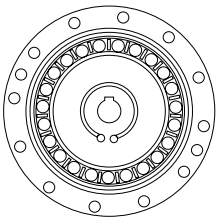

PRINCIPLE AND STRUCTURE

About Harmonic Drive™ strain wave gear principle and structure

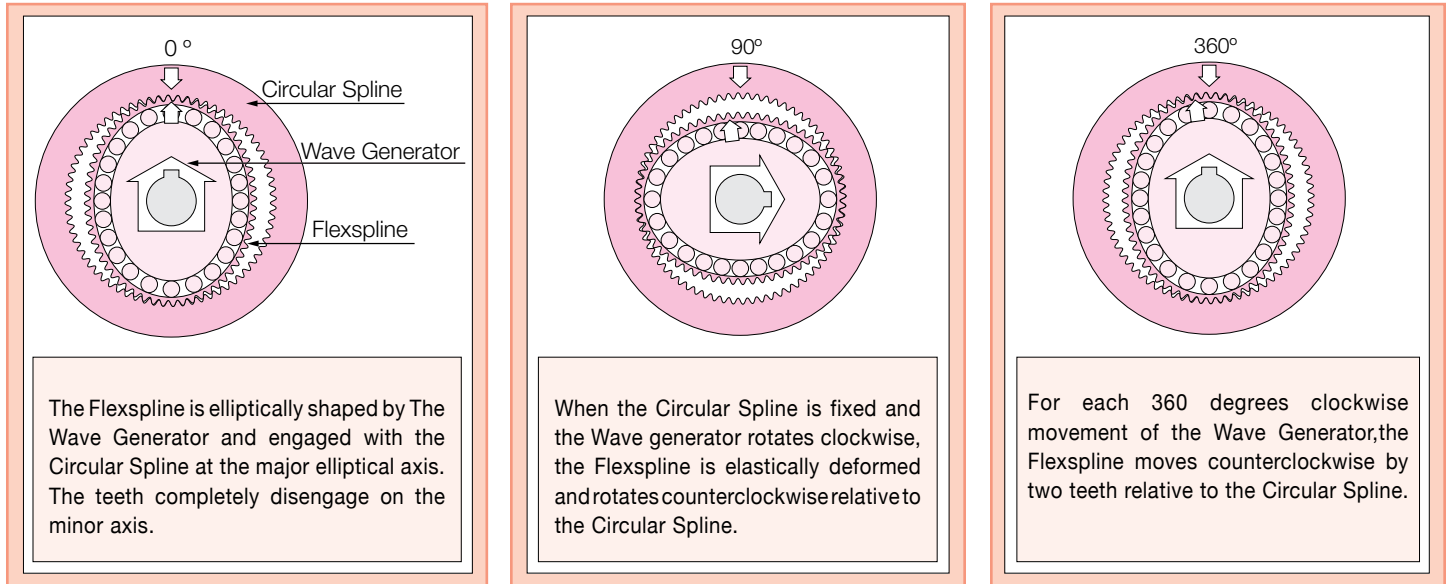

System Components

The Wave Generator: A thin raced ball bearing fitted onto an elliptical plug serving as a high efficiency torque converter.

The Flexspline: A non-rigid, thin cylindrical cup with external teeth on a slightly smaller pitch diameter than the Circular Spline. It fits over and is held in an elliptical shape by the Wave Generator.

The Circular Spline: A rigid ring with internal teeth, engaging the teeth of the Flexspline across the major axis of the Wave Generator.

GEARHEAD TYPE (IU)

This gearhead is easy to use and has both an input and output shaft. It also allows for pulleys to be used for the input and output to the gearhead.

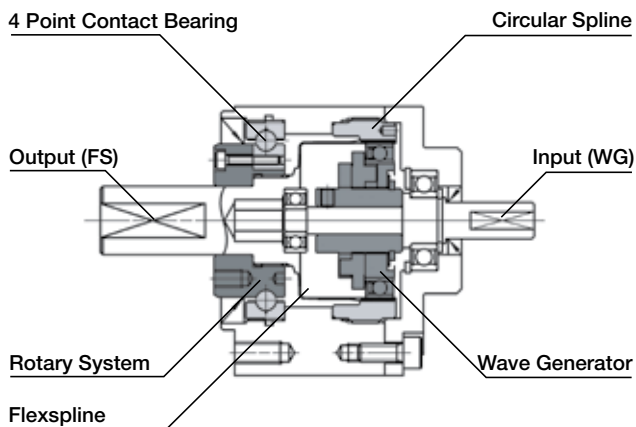

GEARHEAD TYPE (2XH)

This gearhead is designed to be coupled directly to a servo-motor. It is available in 2 models. 2XH-F: Direct input coupling/output Flange. 2XH-J: Direct input coupling/output Shaft.

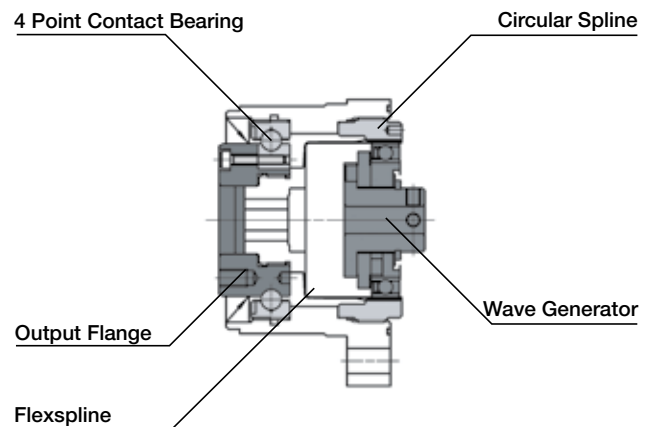

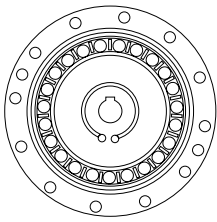

DRIVING CONFIGURATIONS

Driving Configurations

A variety of different driving configurations are possible, as shown below. The reduction ratio given in the tables on page 10 and 11 correspond to arrangement 1, in which the Wave Generator acts as the input element, the Circular Spline is fixed and the Flexspline acts as the output element.

$$\text{Ratio} = \frac{\text{input speed}}{\text{output speed}}$$

1

$$i = \frac{-1}{R}$$

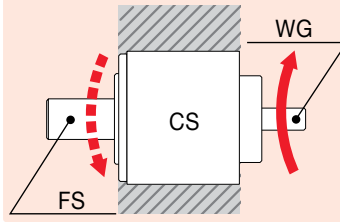

1. Reduction Gearing
 CS Fixed
 WG Input
 FS Output

$$\text{Ratio} = -\frac{R}{1} \quad [\text{Equation 1}]$$

Input and output in opposite direction.

2

$$i = \frac{1}{R+1}$$

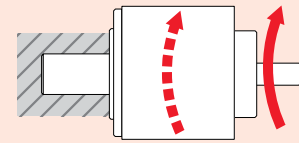

2. Reduction Gearing
 FS Fixed
 WG Input
 CS Output

$$\text{Ratio} = \frac{R+1}{1} \quad [\text{Equation 2}]$$

Input and output in same direction.

3

$$i = \frac{R}{R+1}$$

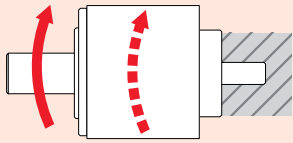

3. Reduction Gearing
 WG Fixed
 FS Input
 CS Output

$$\text{Ratio} = \frac{R+1}{R} \quad [\text{Equation 3}]$$

Input and output in same direction.

4

$$i = \frac{R+1}{R}$$

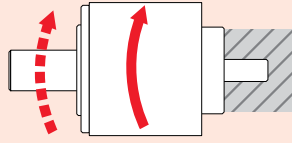

4. Speed Increaser Gearing
 WG Fixed
 CS Input
 FS Output

$$\text{Ratio} = \frac{R}{R+1} \quad [\text{Equation 4}]$$

Input and output in same direction.

5

$$i = -R$$

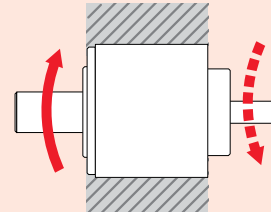

5. Speed Increaser Gearing
 CS Fixed
 FS Input
 WG Output

$$\text{Ratio} = -\frac{1}{R} \quad [\text{Equation 5}]$$

Input and output in opposite direction.

6

$$i = R+1$$

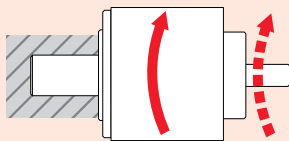

6. Speed Increaser Gearing
 FS Fixed
 CS Input
 WG Output

$$\text{Ratio} = \frac{1}{R+1} \quad [\text{Equation 6}]$$

Input and output in same direction.

7

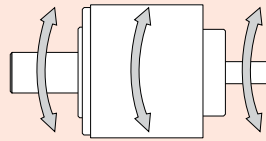

7. Differential Gearing
 WG Control Input
 CS Main Drive-Input
 FS Main Drive-Output

Numerous differential functions can be obtained by combinations of the speed and rotational direction of the three basic elements. [Equation 7]

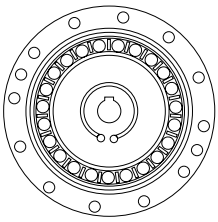

APPLICATION EXAMPLE

Application for 2XH

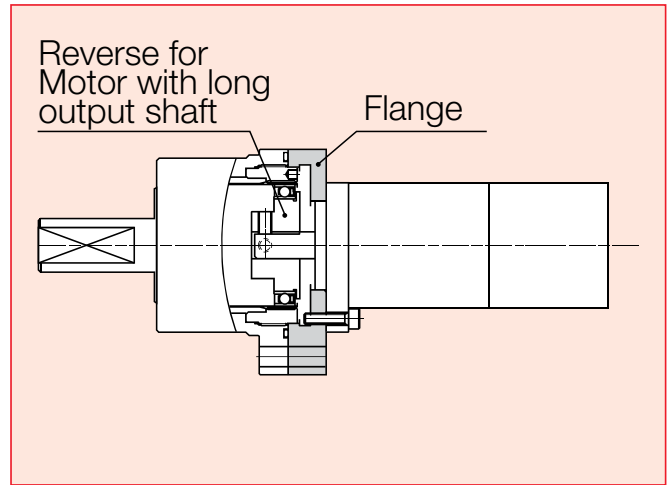
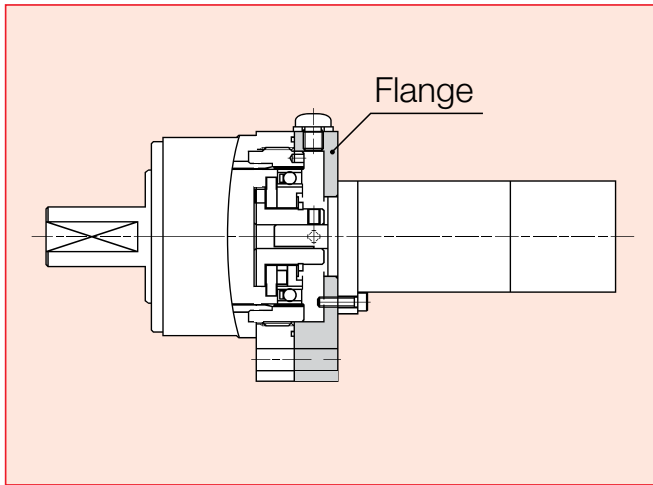

Motor Matching Table

Table 1

Manufacturer	Yaskawa / Σ Mini-Series				Mitsubishi / HC-AQ Series			Matsushita minas
Motor Capacity	3W-5W	10W	20W	30W	10W	20W	30W	30W
CSF-5-2X	•							
CSF-8-2XH		•			•			
CSF-11-2XH			•	•		•	•	•
CSF-14-2XH				•			•	•

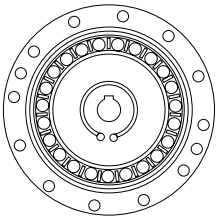

ORDERING INFORMATION

CSF	-	14	-	100	-	2XH - F	-	SP
Name of Model		Size		Gear Ratio		Model		SP

Name	Size	Gear Ratio	Model	SP
CSF	5	30, 50, 100	1U	Customized specification (special) shape and performance
	8	30, 50, 100	2XH-F	
	11	30, 50, 100	2XH-J	
	14	30, 50, 80, 100		

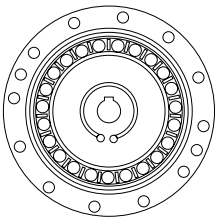

RATING TABLE

Rating Table

Table 2

Size	Gear Ratio	Rated Torque at 2000rpm		Repeated peak torque		Max. average load torque		Max. momentary torque		Max. Input Speed r/min	Avg. Input Speed r/min	Moment of Inertia(1/4 GD) ²	
		Nm	in.lb	Nm	in.lb	Nm	in.lb	Nm	in.lb			1U kgcm ²	2XH kgcm ²
5	30	0.25	2	0.5	4	0.38	3	0.9	8	10,000	6,500	2.5x10 ⁻⁴	2.5x10 ⁻⁴
	50	0.4	4	0.9	8	0.53	5	1.8	16				
	100	0.6	5	1.4	12	0.94	8	2.7	24				
8	30	0.9	8	1.8	16	1.4	12	3.3	29	8,500	3,500	3.0x10 ⁻³	3.2x10 ⁻³
	50	1.8	16	3.3	29	2.3	20	6.6	58				
	100	2.4	21	4.8	42	3.3	29	9.0	80				
11	30	2.2	19	4.5	40	3.4	30	8.5	75	8,500	3,500	1.2x10 ⁻²	1.4x10 ⁻²
	50	3.5	31	8.3	73	5.5	49	17	150				
	100	5.0	44	11	97	8.9	79	25	221				
14	30	4.0	35	9.0	80	6.8	60	17	150	8,500	3,500	3.3x10 ⁻²	3.4x10 ⁻²
	50	5.4	48	18	159	6.9	61	35	310				
	80	7.8	69	23	204	11	97	47	416				
	100	7.8	69	28	248	11	97	54	478				

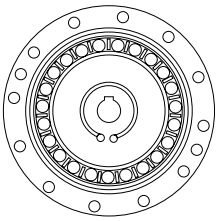

TECHNICAL TERMS

Definition of Ratings

Rated Torque (Tr)

Rated torque indicates allowable continuous load torque at 2000 rpm input speed.

Limit for Repeated Peak Torque (figure 1)

During acceleration a deceleration the Harmonic Drive™ gear experiences a peak torque as a result of the moment of inertia of the output load.

Limit for Average Torque

In cases where load torque and input speed vary, it is necessary to calculate an average value of load torque. The table indicates the limit for average torque. The average torque calculated must not exceed this limit.

Limit for Momentary Peak Torque (figure 1)

The gear may be subjected to momentary peak torques in the event of a collision or emergency stop. The magnitude and frequency of occurrence of such peak torques must be kept to a minimum and they should, under no circumstance, occur during normal operating cycle. The allowable number of occurrences of the momentary peak torque may be calculated by using equation 8 on page 8. Also see section "strength and life".

Figure 1

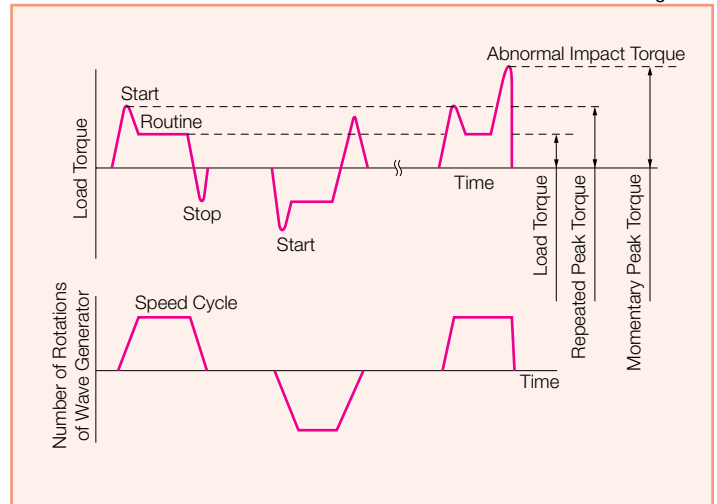

Maximum Input Speed, Limit for average input speed
Do not exceed the allowable rating.

Moment of Inertia

The rating indicates the moment of inertia reflected to the wave generator (gear input).

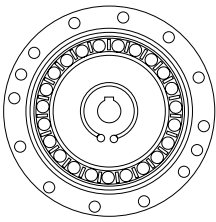

STRENGTH AND LIFE

Strength and Life

The non-rigid Flexspline is subjected to repeated deflections, and its strength determines the torque capacity of the Harmonic Drive™ gear. The values given for Rated Torque at Rated Speed and for the allowable Repeated Peak Torque are based on an infinite fatigue life for the Flexspline.

The torque that occurs during a collision must be below the momentary peak torque (impact torque). The maximum number of occurrences is given by the equation below.

[Equation 8]

$$N = \frac{1.0 \times 10^4}{2 \times \frac{Tr}{Tav} \times \frac{Nr}{Nav}}$$

n: Input speed before collision
t: Time interval during collision

Please note:
If this number is exceeded, the Flexspline may experience a fatigue failure.

Ratcheting phenomenon

When excessive torque is applied while the gear is in motion, the teeth between the Circular Spline and Flexspline may not engage properly. This phenomenon is called ratcheting and the torque at which this occurs is called ratcheting torque. Ratcheting may cause the Flexspline to become non-concentric with the Circular Spline.

(See figure 2 and 3 on page 8) Operating in this condition may result in shortened life and a Flexspline fatigue failure.

Note!

When ratcheting occurs, the teeth mesh abnormally as shown above. Vibration and Flexspline damage may occur. Once ratcheting occurs, the teeth wear excessively and the ratcheting torque may be lowered.

Figure 2

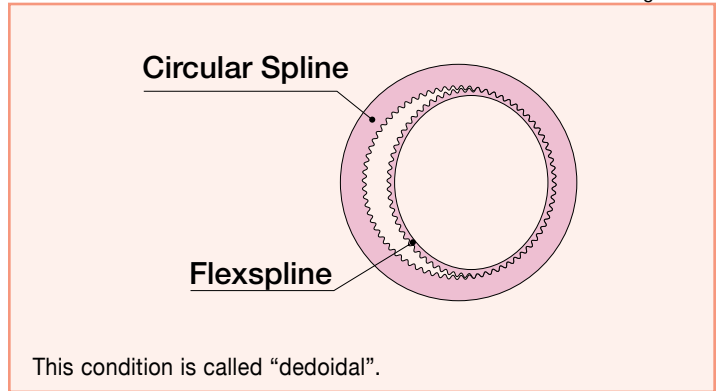

Size	Gear Ratio			Nm
	30	50	80	
5	2.7	3.2	-	3.5
8	11	12	-	14
11	29	34	-	43
14	59	88	110	84

Size	All Ratio
5	9.8
8	35
11	90
14	190

The Life of a Wave Generator

The normal life of a gear is determined by the life of the wave generator bearing. The life may be calculated by using the input speed and the output load torque.

Rated Lifetime Ln : (n = 10 or 50)

L10	CSF : 7,000	CSG : 10,000
L50	CSF : 35,000	CSG : 50,000

Equation for the expected life of the wave generator under normal operating conditions is given by the equation below.

[Equation 9]

$$Lh = Ln \cdot \left(\frac{Tr}{Tav}\right)^3 \cdot \left(\frac{Nr}{Nav}\right)$$

- Lh : Expected Life, hours
- Ln : Rated Lifetime at L10 or L50
- Tr : Rated Torque (Table 2)
- Nr : Rated input speed (2000 rpm)
- Tav : Average load torque on output side (page 9)
- Nav : Average input speed (page 9)

Relative Torque Rating

The chart below shows the various torque specifications relative to rated torque. Rated Torque has been normalized to 1 for comparison.

Figure 3

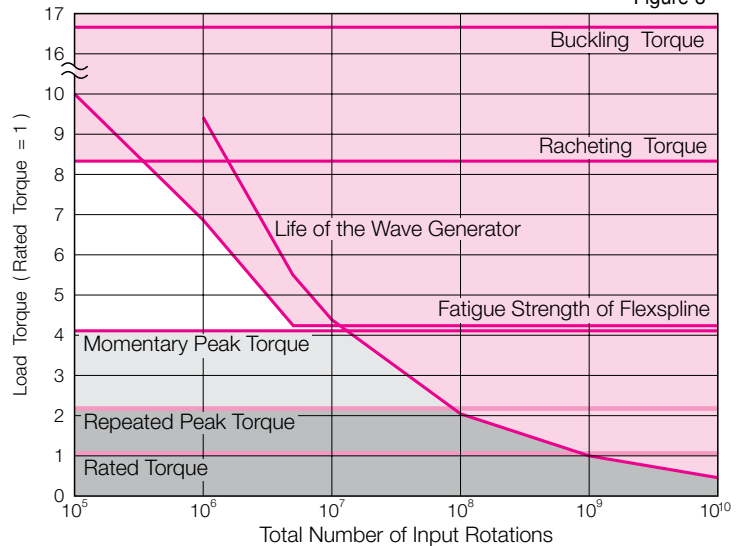

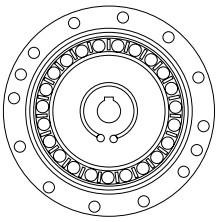

SELECTION PROCEDURE

Size Selection

Generally, the operating conditions consist of fluctuating torques and output speeds. Also, an unexpected impact output torque must be considered.

The proper size can be determined by converting fluctuating load torque into average load torque and equivalent load torque. This procedure involves selecting the size based on load torque for component sets.

This procedure does not consider the life of the output bearing for housed units. Determining the life of the output bearing for various axial, radial, and moment loads is outlined on page 12.

Figure 4

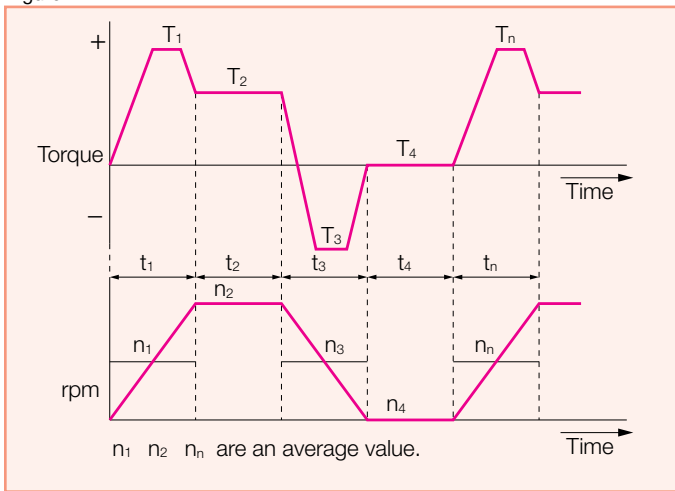

Parameters	
Load Torque	Tn (Nm)
Time	tn (sec)
Output Speed	nn (rpm)
Normal Operating Pattern	
Acceleration	T ₁ , t ₁ , n ₁
Regular Operation	T ₂ , t ₂ , n ₂
Deceleration	T ₃ , t ₃ , n ₃
Dwell	T ₄ , t ₄ , n ₄
Maximum RPM	
Max output speed	no maximum
Max input speed	ni maximum
Impact Torque	
	T _s , t _s , n _s
Ratings	
Rated Torque	Tr
Rated Speed	nr = 2000 rpm
Life	L ₁₀ = L (hrs)

Flow Chart for Selecting a Size

Please use the flowchart shown below for selecting a size. Operating conditions must not exceed the performance ratings as described on page 7.

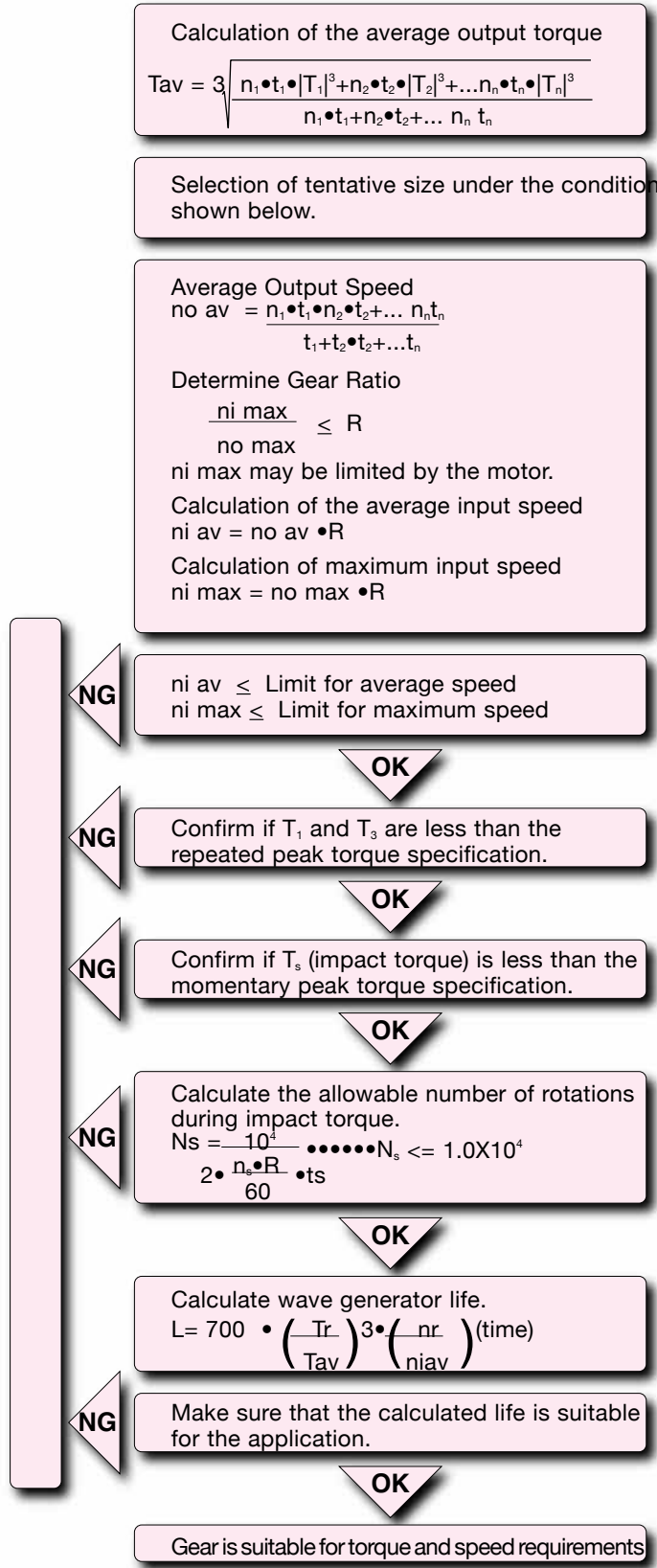

Also consider output bearing, environment, etc.

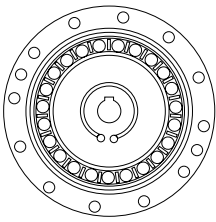

SELECTION EXAMPLE

Values of an each Load Torque Pattern

Load Torque	T_n (Nm)
Time	t_n (sec)
Output Speed	n_n (rpm)

Normal Operating Pattern

Acceleration	$T_1 = 19 \text{ Nm}$, $t_1 = 0.4 \text{ sec}$, $n_1 = 8 \text{ rpm}$
Regular Operation Stop	$T_2 = 2 \text{ Nm}$, $t_2 = 4 \text{ sec}$, $n_2 = 16 \text{ rpm}$
Deceleration	$T_3 = 19 \text{ Nm}$, $t_3 = 0.4 \text{ sec}$, $n_3 = 8 \text{ rpm}$
Dwell	$T_4 = 0 \text{ Nm}$, $t_4 = 0.2 \text{ sec}$, $n_4 = 0 \text{ rpm}$

Maximum Speed

output max speed $n_o \text{ max} = 16 \text{ rpm}$
input max speed $n_i \text{ max} = 1800 \text{ rpm}$
(limited by motor)

Impact Torque

$T_s = 50 \text{ Nm}$, $t_s = 0.15 \text{ sec}$, $n_s = 12 \text{ rpm}$

Life Required

$L_{10} = 7000 \text{ hrs.}$

T_{av} (Nm)

$$T_{av} = \sqrt[3]{\frac{8\text{rpm} \cdot 0.4\text{sec} \cdot |19\text{Nm}|^3 + 16\text{rpm} \cdot 4\text{sec} \cdot |2\text{Nm}|^3 + 8\text{rpm} \cdot 0.4\text{sec} \cdot |19\text{Nm}|^3}{8\text{rpm} \cdot 0.4\text{sec} + 16\text{rpm} \cdot 4\text{sec} + 8\text{rpm} \cdot 0.4\text{sec}}}$$

$$T_{av} = 8.6\text{Nm} \leq 11\text{Nm} \text{ (for CSF-14-100-2XH)}$$

$n_{o \text{ av}}$ (rpm)

$$n_{o \text{ av}} = \frac{8\text{rpm} \cdot 0.4\text{sec} + 16\text{rpm} \cdot 4\text{sec} + 8\text{rpm} \cdot 0.4\text{sec}}{0.3\text{sec} + 3\text{sec} + 0.4\text{sec} + 0.2\text{sec}} = 14\text{rpm}$$

(R)

$$\frac{1800 \text{ rpm}}{14 \text{ rpm}} = 129 \geq 100$$

$$n_i \text{ av} = 14 \text{ rpm} \cdot 100 = 1400 \text{ rpm}$$

$$n_o \text{ max} = n_i \text{ max (rpm)}$$

$$n_i \text{ max} = 16 \text{ rpm} \cdot 100 = 1600 \text{ rpm}$$

$$n_i \text{ av} = 1400 \text{ rpm} \leq 3500 \text{ rpm} \text{ (for CSF-14-100-2XH)}$$

$$n_i \text{ max} = 1600 \text{ rpm} \leq 8500 \text{ rpm} \text{ (for CSF-14-100-2XH)}$$

OK

Confirm that T_1 and T_3 are within a

T_1, T_3 (Nm)

$$T_1 = 19\text{Nm} \leq 28\text{Nm} \text{ (for CSF-14-100-2XH)}$$

$$T_3 = 19\text{Nm} \leq 28\text{Nm} \text{ (for CSF-14-100-2XH)}$$

OK

T_s (Nm)

$$T_s = 50\text{Nm} \leq 54\text{Nm} \text{ (for CSF-14-100-2XH)}$$

OK

(N_s) Calculate an allowable number of rotation(N_s) and confirm $\leq 1.0 \times 10^4$

$$N_s = \frac{10^4}{2 \cdot \frac{16\text{rpm} \cdot 100}{60} \cdot 0.15\text{sec}} = 1250 \leq 1.0 \times 10^4$$

OK

$$L_{10} = 7000 \cdot \left(\frac{7.8 \text{ Nm}}{8.6 \text{ Nm}} \right)^3 \cdot \left(\frac{2000 \text{ rpm}}{1400 \text{ rpm}} \right)$$

$$L_{10} = 7460 \geq 7000 \text{ (} L_{B10} \text{)}$$

OK

CSF-14-100-2XH

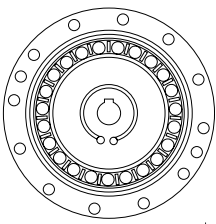

EXTERNAL DIMENSIONS

Compact Double Shaft Type 1U This gearhead is easy to use and has both an input and output shaft.

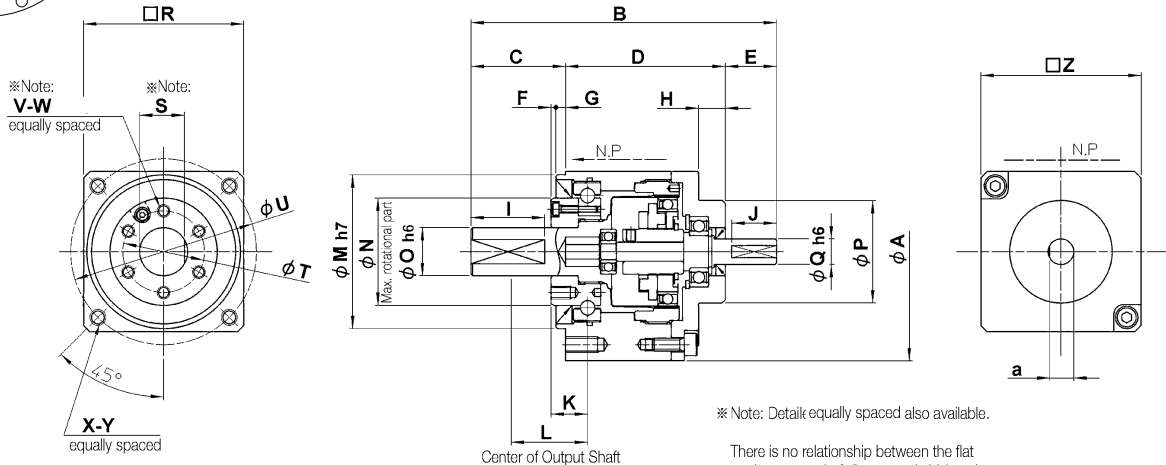

Table 4

Symbol	Size	5	8	11	14
øA		26.5	40	54	68
B		37	65.5	82.5	95.4
C		13	23	29.5	29.5
D		16	29.5	37	49.9
E		8	13	16	16
F		0.5	0.5	0.5	1.5
G		2.5	2.5	3	3
H		0.8	2.6	3.9	8.4
I		9	18	21.5	23
J		7	11	14	14

Table 5

Symbol	Size	5	8	11	14
K		4.85	7.3	9	11.4
L		9.85	17.3	22	23.9
øM h7		19.5	29	39	48
øN		13	20	26.5	33.5
øO h6		5	9	12	15
øP		9	16	24	32
øQ h6		3	5	6	8
□R		20.4±0.42	30.7±0.46	40.9±0.50	51.1±0.50
S		4.6	8	10.5	14
øT		9.8	15.5	20.5	25.5

Table 6

Symbol	Size	5	8	11	14	m
øU		23	35	46	58	
V		3	4	6	6	
W		M2X3	M3X4	M3X5	M4X6	
X		4	4	4	4	
Y		M2X3	M3X6	M4X8	M5X10	
□Z		20±0.42	30±0.46	40±0.50	50±0.50	
a		2.6	4.5	5.5	7.5	
weight(g)		35	130	240	440	

Gearhead Type 2XH-F This gearhead is designed to be coupled directly to a servomotor. The motor shaft is attached directly to the gearhead input element. The output of the gearhead is a flange.

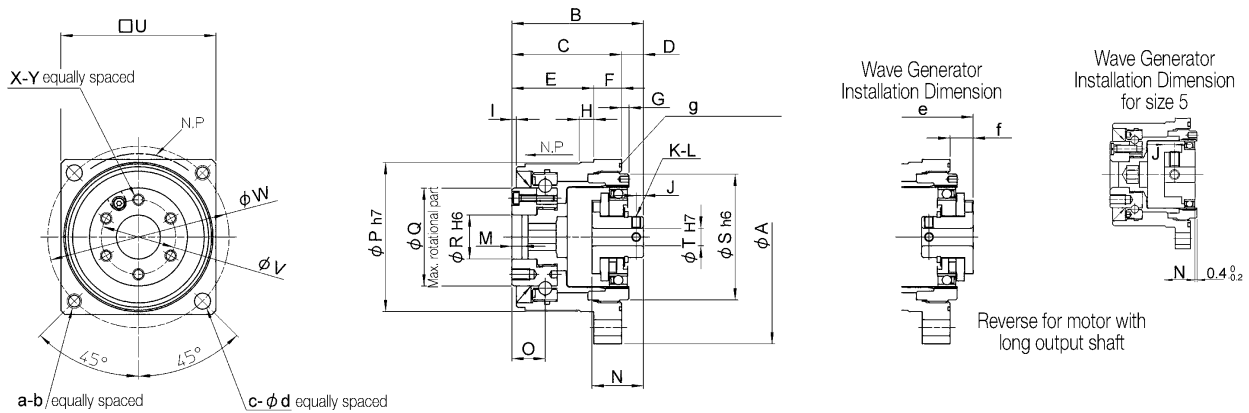

Table 7

Symbol	Size	5	8	11	14
øA		29	43.5	58	73
B		17	31	38.3	45
C		15.7	24.5	30	37.5
D		-	6.5 ⁰ _{-0.3}	8.3 ⁰ _{-0.7}	7.5 ⁰ _{-0.8}
E		12.7	19	23.5	28
F		3	5.5	6.5	9.5
G		1.3	1.5	2	2.5
H		2	3	3	5
I		0.5	0.5	0.5	1.5
J		2	2	3	2.5
K		2	2	2	2

Table 8

Symbol	Size	5	8	11	14
L		M2X3	M2X3	M3X4	M3X4
M		1.7	2.2	2.5	3.5
N		6	12	16	17.6
O		4.85	7.3	9	11.4
øP h7		20.5	31	40.5	51
øQ		13	20	26.5	33.5
øR H6		5	9	12	15
øS h6		17	26	35	43
øT H7		3	3	5	6
□øU		22±0.42	30±0.46	43±0.50	53±0.50
øV		9.8	15.5	20.5	25.5

Table 9

Symbol	Size	5	8	11	14	mm
øW		25	37.5	50	62	
X		3	4	6	6	
Y		M2X3	M3X4	M3X5	M4X6	
a		2	2	2	2	
b		M2	M3	M4	M5	
c		2	2	2	2	
ød		2.3	3.4	4.5	5.5	
e		-	28.7	36.1	45.4	
f		-	4.2 ⁰ _{0.3}	6.1 ⁰ _{0.7}	7.9 ⁰ _{0.8}	
g		18.90±0.70	28.20±1.00	38.00±1.50	48±1.00	
weight(g)		25	100	150	295	

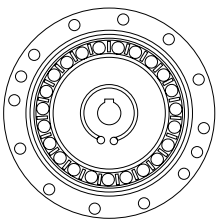

EXTERNAL DIMENSIONS & OUTPUT BEARING RATINGS

Gearhead Type 2XH-J This gearhead is designed to be coupled directly to a servomotor. The motor shaft is attached directly to the gearhead input element. The output of the gearhead is a shaft.

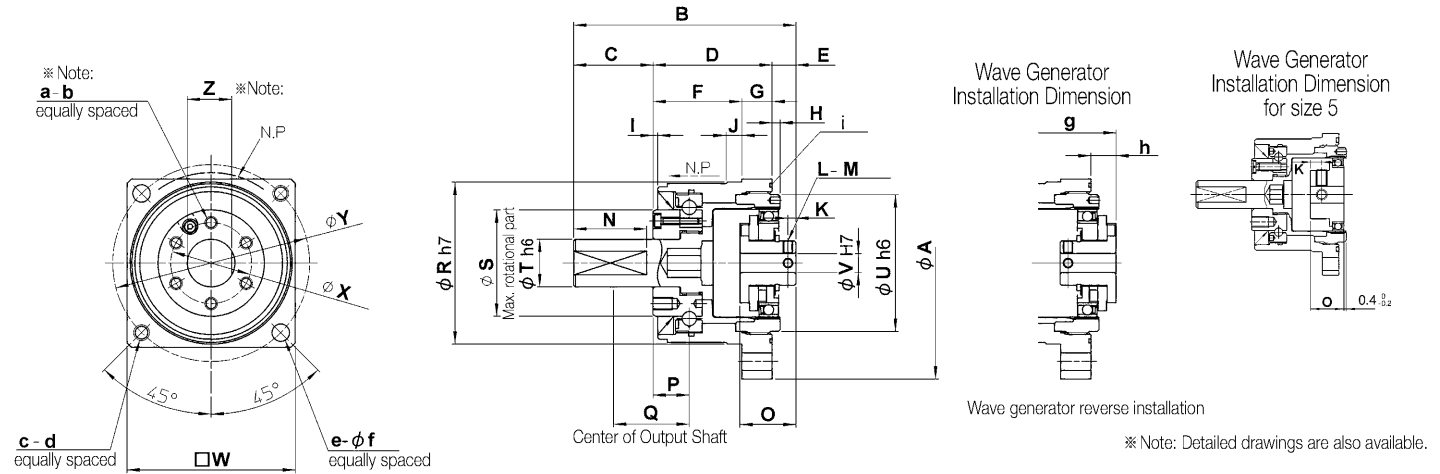

Table 10

Symbol	Size	5	8	11	14
φA		29	43.5	58	73
B		25.7	51	64.3	70
C		10	20	26	25
D		15.7	24.5	30	37.5
E		-	6.5 ⁰ _{-0.3}	8.3 ⁰ _{-0.7}	7.5 ⁰ _{-0.8}
F		12.7	19	23.5	28
G		3	5.5	6.5	9.5
H		1.3	1.5	2	2.5
I		0.5	0.5	0.5	1.5
J		2	3	3	5
K		2	2	2	2.5
L		2	2	2	2

Table 11

Symbol	Size	5	8	11	14
M		M2X3	M2X3	M3X4	M3X4
N		9	18	21.5	23
O		6	12	16	17.6
P		4.85	7.3	9	11.4
Q		9.85	17.3	22	23.9
φR h7		20.5	31	40.5	51
φT h6		5	9	12	15
φU h6		17	26	35	43
φV H7		3	3	5	6
□W		22±0.42	32±0.46	43±0.50	53±0.50
φX		9.8	15.5	20.5	25.5

Table 12

Symbol	Size	5	8	11	14	m
φY		25	37.5	50	62	
Z		4.6	8	10.5	14	
a		3	4	6	6	
b		M2X3	M3X4	M3X5	M4X6	
c		2	2	2	2	
d		M2	M3	M4	M5	
e		2	2	2	2	
φf		2.3	3.4	4.5	5.5	
(g)		-	48.7	62.1	70.4	
h		-	4.2 ⁰ _{-0.3}	6.1 ⁰ _{-0.7}	7.9 ⁰ _{-0.8}	
i		18.90 X 0.70	28.20 X 1.00	38.00 X 1.50	48.00 X 1.00	
weight(g)		27	111	176	335	

Specification for Output Bearing

CSF-Mini Series incorporate a precise 4-point contact bearing to directly support a load. The inner race of the bearing forms the output flange. Please calculate maximum load moment, life of cross roller bearing, and static safety factor to fully maximize the performance of the CSF-Mini Series.

Calculation Procedure

1. Maximum Load Moment (Mmax)

Calculate maximum load moment

Maximum load moment (Mmax) < Allowable moment (Mc)

2. Output Bearing Life

Calculate average radial load (F_{rav}) and average axial load (F_{aav})

Calculate radial load coefficient (X) and axial load coefficient (Y)

Calculate lifetime

3. Static Safety Factor

Calculate static equal radial load (P_o)

Confirm static safety factor (f_s)

Specification for Output Bearing

Table 13

Size	Pitch Circle dp mm	Offset R mm	Basic Dynamic Rated Load C		Basic Static Rated Load Co		Allowable Moment Load Mc		Moment Rigidity Km Nm/rad	in-lb arc-min	Allowable Radial Load		Allowable Thrust Load	
			x10 ² N	lb	x10 ² N	lb	Nm	in-lb			N	lb	N	lb
5	13.5	4.85	9.14	205	7.63	171	0.89	8	7.41X10 ²	1.9	90	20.2	270	60.6
8	20.5	7.3	21.6	485	19.0	427	3.46	31	2.76X10 ³	7.09	200	44.9	630	141
11	27.5	9	38.9	874	35.4	795	6.6	58	7.41X10 ³	19	300	67.4	1,150	258
14	35	11.4	61.2	1,376	58.5	1,315	13.2	117	1.34X10 ⁴	34.4	550	123	1,800	404

Allowable Radial Load is based on load acting at the middle of the output shaft 1U and gearhead type 2XH-J

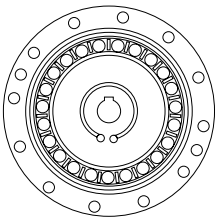

OUTPUT BEARING RATINGS

How to Calculate the Maximum Load Moment

How to calculate the Maximum load moment is shown below. Please be sure that M_c is equal or greater than M_{max} .

$$M_{max} = F_{rmax} \cdot (L_r + R) + F_{amax} \cdot L_a$$

F_{rmax}	Max. radial load	N	Figure 6
F_{amax}	Max. axial load	N	Figure 6
L_r, L_a	Moment arm	m	Figure 5
R	amount of offset	m	Table 13

How to Calculate an Average Load

To calculate average radial load, average axial load or average output speed, follow steps below.

When the radial load and axial load vary, the life of cross roller bearing can be determined by converting to an average load. (see figure 6)

Equation (10) Calculate Average Radial Load

$$F_{rav} = \sqrt[10/3]{\frac{n_1 t_1 |F_{r1}|^{10/3} + n_2 t_2 |F_{r2}|^{10/3} \dots + n_n t_n |F_{rn}|^{10/3}}{n_1 t_1 + n_2 t_2 \dots + n_n t_n}}$$

However Max. radial load in t_1 is F_{r1} , Max. radial load in t_3 is F_{r3} .

Equation (11) Calculate Average Axial Load (F_{aav})

$$F_{aav} = \sqrt[10/3]{\frac{n_1 t_1 |F_{a1}|^{10/3} + n_2 t_2 |F_{a2}|^{10/3} \dots + n_n t_n |F_{an}|^{10/3}}{n_1 t_1 + n_2 t_2 \dots + n_n t_n}}$$

However, an axial load in t_1 is F_{a1} , Max. axial load in t_3 is F_{a3} .

Equation (12) Calculate Average Output Speed

$$N_{av} = \frac{n_1 t_1 + n_2 t_2 \dots + n_n t_n}{t_1 t_2 \dots + t_n}$$

How to calculate radial load coefficient (X) axial load (Y)

		list 2	
		X	Y
F_{aav}			
$F_{rav} + 2 (F_{rav} (L_r + R) + F_{aav} L_a) / dp$	≤ 1.5	1	0.45
F_{aav}			
$F_{rav} + 2 (F_{rav} (L_r + R) + F_{aav} L_a) / dp$	> 1.5	0.67	0.67

F_{rmax}	Max. radial load	N	Figure 6
F_{amax}	Max. axial load	N	Figure 6
L_r, L_a	Moment arm	m	Figure 5
R	amount of offset	m	Table 13
dp	pitch circle	m	Table 13

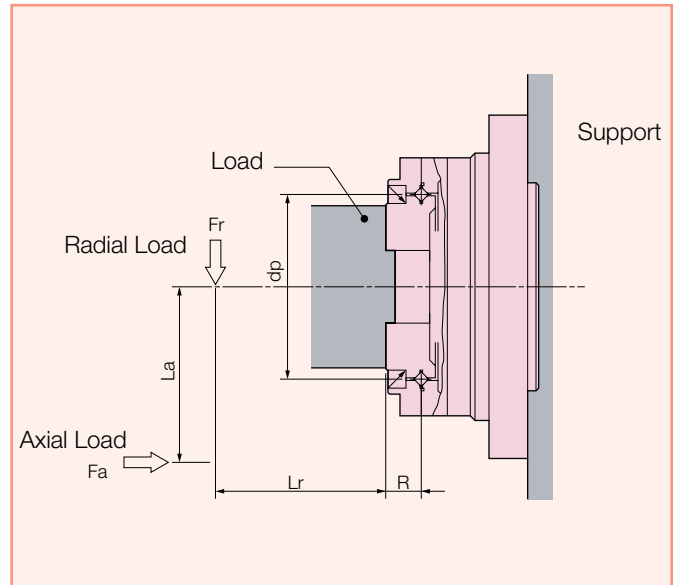
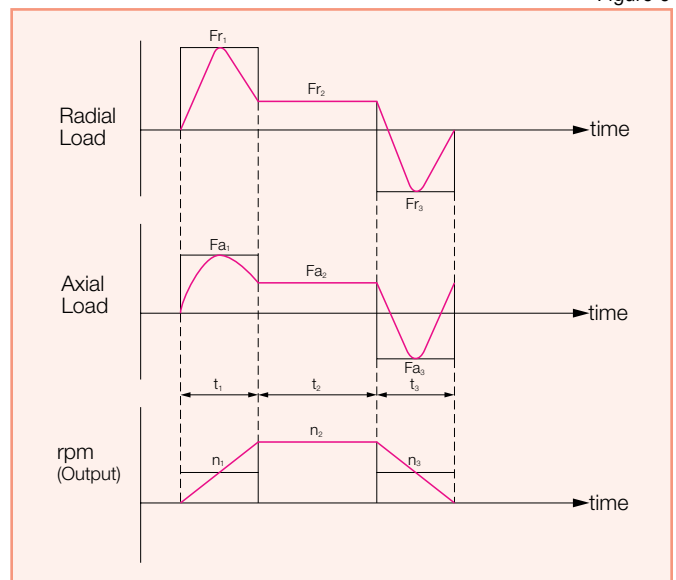
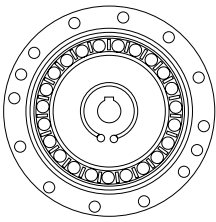

Figure 6





SPECIFICATIONS OF CROSS ROLLER BEARING

How to Calculate Life of the Output Bearing

The life of a cross roller bearing can be calculated by equation (13).

$$L_{10} = \frac{10^6}{60 \times N_{av}} \times \left(\frac{C}{f_w \cdot P_c} \right)^{10/3} \quad \text{equation (13)}$$

Equation 15

L_{10}	Life	Hour	-----
N_{av}	Average Output Speed	rpm	equation 12
C	Basic Dynamic Rated Load	N	table 13
P_c	Dynamic Equivalent	N	equation 14
f_w	Load Coefficient	-----	list 3

List 3

Load Coefficient, f_w

Steady operation without impact and vibration	1~1.2
Normal operation	1.2~1.5
Operation with impact and vibration	1.5~3

Dynamic Equivalent Radial Load

equation (14)

$$P_c = X \cdot \left(2 \frac{F_{rav} (L_r + R) + F_{aav} \cdot L_a}{dp} \right) + Y \cdot F_{aav}$$

Symbol of equation

F_{rav}	Average radial load	N	equation 10
F_{aav}	Average axial load	N	equation 11
dp	Pitch diameter	m	table 13
X	Radial load coefficient	-----	list 2
Y	Axial load coefficient	-----	list 2
L_r, L_a	Moment Arm	m	figure 5
R	Offset	m	figure 7 and table 13

How to Calculate Static Safety Coefficient

Basic static rated load is an allowable limit for static load, but its limit is determined by usage. In this case, static safety coefficient of the cross roller bearing can be calculated by equation (15). Reference values under general conditions are shown on list 4. Static equivalent radial load can be calculated by equation (15)

$$f_s = \frac{C_o}{P_o} \quad \text{equation (15)}$$

Symbols for equation (17)

C_o	Basic static rated load	N	table 13
P_o	Static equivalent radial load	N	refer to equation (17)

list 4

Rotating Conditions	Load Conditions	Lower Limit Value for f_s
Normally not rotating	Slight oscillations	≥ 2
	Impact loads	≥ 3
Normally rotating	Normal loads	≥ 1.5
	Impact loads	≥ 3
Static Safety Coefficient	High Accuracy Required	≥ 3
	Oscillations, Impact Loads	≥ 2
	Normal Loads	≥ 1.5

How to Calculate Life for Oscillating Motion

The Life of a cross roller bearing in a oscillating operation can be calculated by equation 9

$$L_{oc} = \frac{106}{60 \times n1} \times \frac{90}{\emptyset} \times \left(\frac{C}{f_w \cdot P_c} \right)^{10/3}$$

equation (16)

Symbol of equation

L_{oc}	Rated life for oscillating motion	Hour	-----
$n1$	Round trip oscillation each minute	rpm	-----
C	Basic dynamic rated load	N	-----
P_c	Dynamic equivalent radial load	N	equation 14
f_w	Load Coefficient	-----	list 3
\emptyset	Angle of oscillation/2	degrees	refer to figure

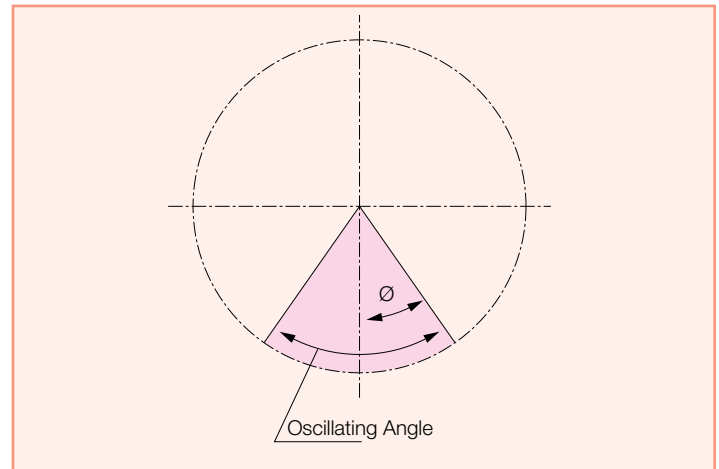

A small angle of oscillation (less than 5 degrees) may cause fretting corrosion to occur since lubrication may not circulate properly.

$$P_o = F_{rmax} + \frac{2M_{max}}{dp} + 0.44 \cdot F_{amax} \quad \text{equation (17)}$$

Symbols for Equation (17)

F_{rmax}	Max. radial load	N
F_{amax}	Max. axial load	N
M_{max}	Max. moment load	Nm
dp	Pitch diameter	m

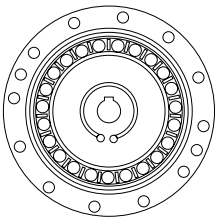

EFFICIENCY

Efficiency The efficiency depends on the conditions shown below. Efficiency depends on gear ratio, input speed, load torque, temperature, quantity of lubricant and type of lubricant. Efficiency values shown are for rated torque. If load torque is below rated torque, a compensation factor must be employed. Load Torque \geq Rated Torque: Efficiency = Efficiency from Graph Load Torque $<$ Rated Torque: Efficiency = Efficiency from Graph x Compensation Coefficient from figure 9.

Measurement Condition

Installation : Based on recommended tolerance
 Load torque : Rated torque
 Lubricant : Harmonic Grease SK-2 only
 Grease quantity : Recommended quantity
 Please contact us for details pertaining to recommended oil lubricant.

Size 5

1U-2XH

Figure 1 Ratio 30

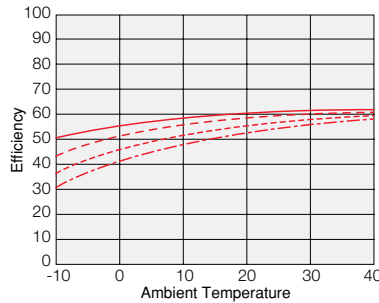

Figure 2 Ratio 50

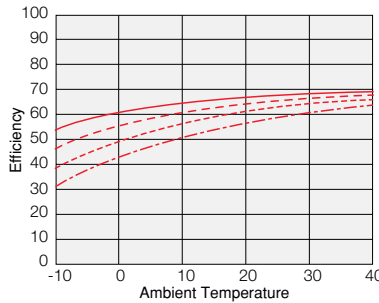
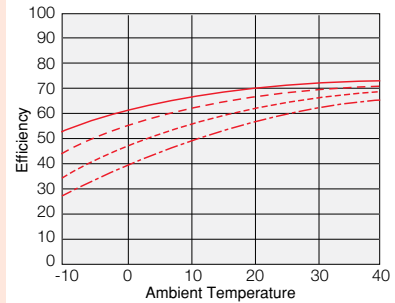

Figure 3 Ratio 100



Input Speed ————— 500r/min - - - - - 1000r/min - - - - - 2000r/min - - - - - 3500r/min

Size 8

1U

Figure 4 Ratio 30

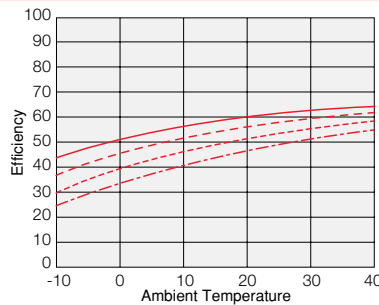

Figure 5 Ratio 50

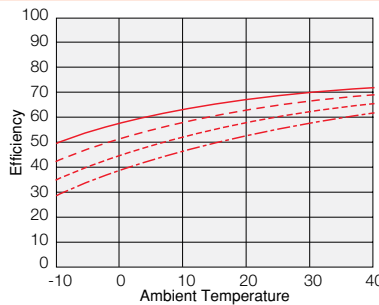
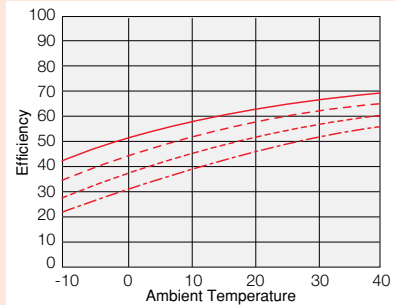

Figure 6 Ratio 100



2XH

Figure 7 Ratio 30

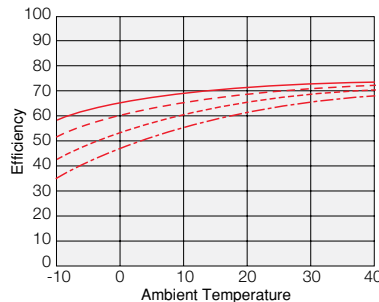

Figure 8 Ratio 50

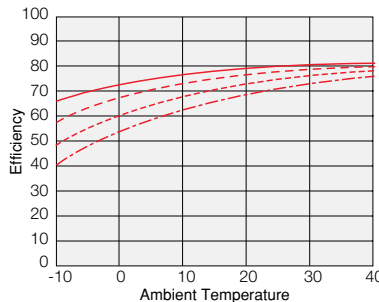
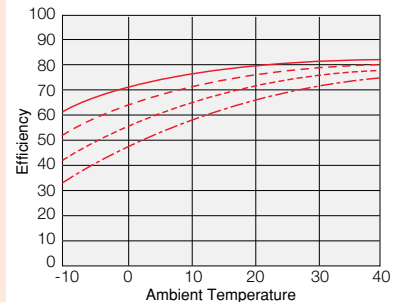

Figure 9 Ratio 100



Input Speed ————— 500r/min - - - - - 1000r/min - - - - - 2000r/min - - - - - 3500r/min

Efficiency Compensation Coefficient

Find the Compensation Coefficient (Ke) from graph (a) and calculate the Efficiency.

*For example Find the Efficiency n (%) on following condition that using model

- CSF-8-100-2XH
- Input speed : 1000 r/min
- Load torque : 2.0N.m
- Type of lubricant : grease
- Temperature : 20°C

Size 8—ratio 100, rated torque= 2.4N.m (see rated table, page 07)

- Torque a = 2.0/2.4 = 0.83
- Efficiency Compensation Coefficient Ke = 0.99
- Load torque = 2.0Nm
- Efficiency n = Ke * nR = 0.99 x 77 = 76%

*The load torque is greater than the rated torque : The Efficiency Compensation Coefficient Ke=1

Graph (a)

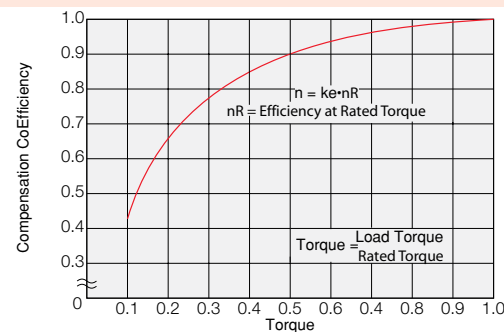

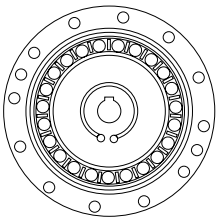

EFFICIENCY

Size 11

1U

Figure 10 Ratio 30

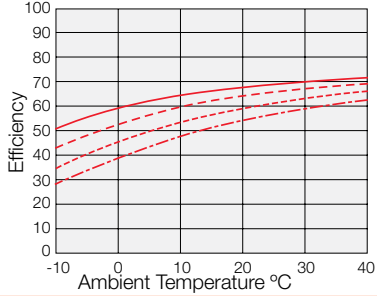

Figure 11 Ratio 50

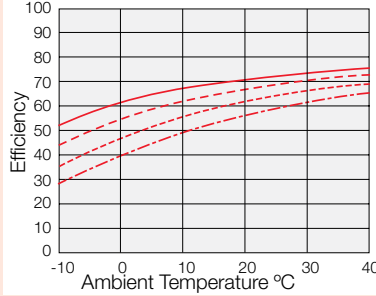
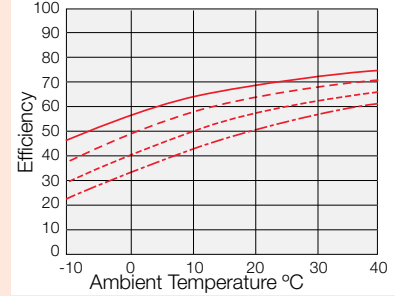

Figure 12 Ratio 100



2XH

Figure 13 Ratio 30

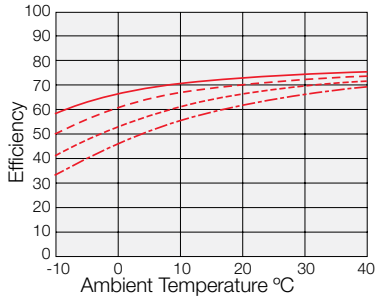

Figure 14 Ratio 50

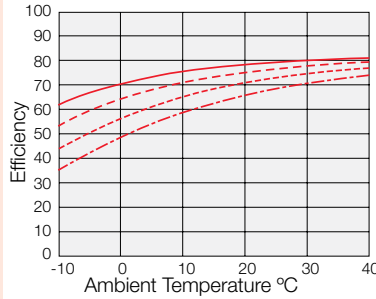
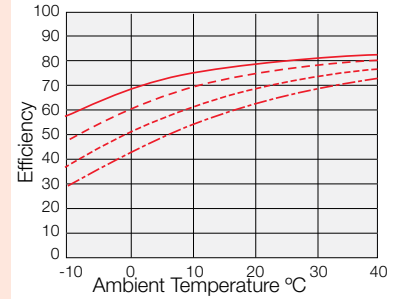

Figure 15 Ratio 100



Input — 500r/min - - - 1000r/min - - - - 2000r/min - - - - - 3500r/min

Size 14

1U

Figure 16 Ratio 30

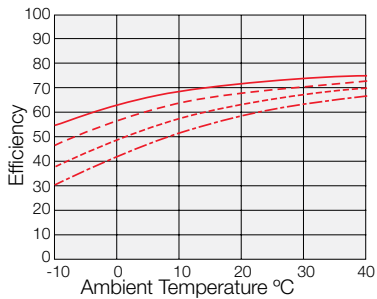

Figure 17 Ratio 50

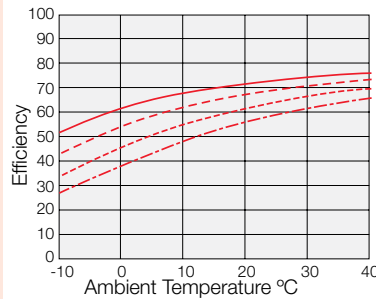
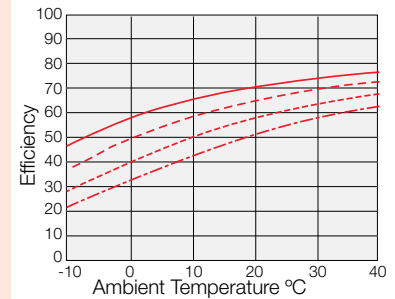

Figure 18 Ratio 80, 100



2XH

Figure 19 Ratio 30

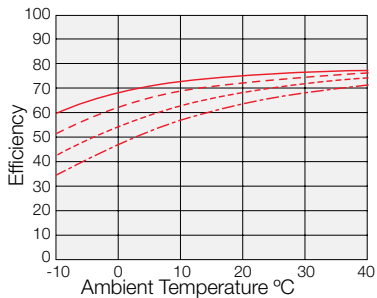

Figure 20 Ratio 50

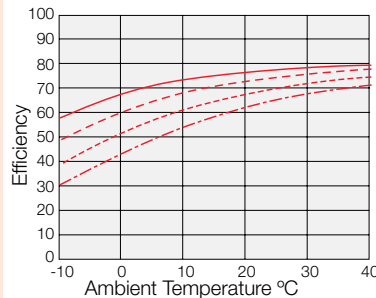
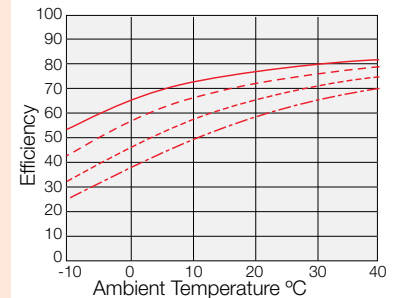
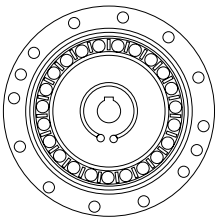

Figure 21 Ratio 80, 100



Input — 500r/min - - - 1000r/min - - - - 2000r/min - - - - - 3500r/min



No Load Running Torque

No Load Running Torque

No load running torque indicates the torque which is needed to rotate input of the gear, "Wave Generator", with no load on the output side (low speed side). Please contact us regarding details."

Compensation Value in Each Ratio (Component Set)

No load running torque of the gear varies with ratio. The graphs indicate a value for ratio 100.

For other gear ratios, add the compensation values from table 34.

Measurement condition

Ratio : 1/100

Lubricant : Harmonic Grease SK-2

Quantity : Recommended quantity

see page 19

Torque value is measured after 2 hours at 2000rpm input.

In case of oil lubricant, please contact us.

1U

Input Speed 500r/min

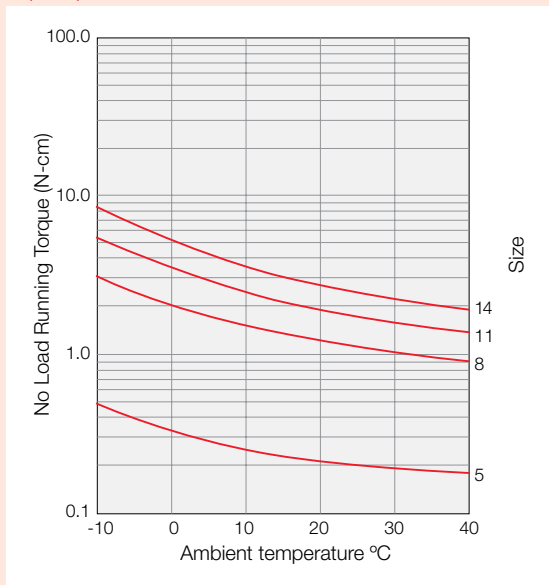

Input Speed 1000r/min

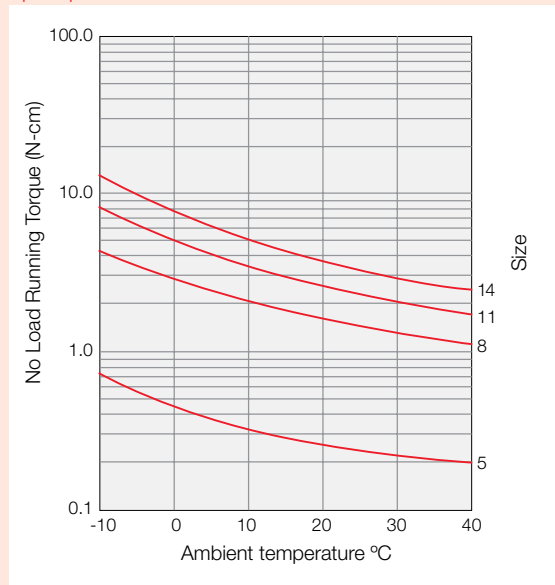

Input Speed 2000r/min

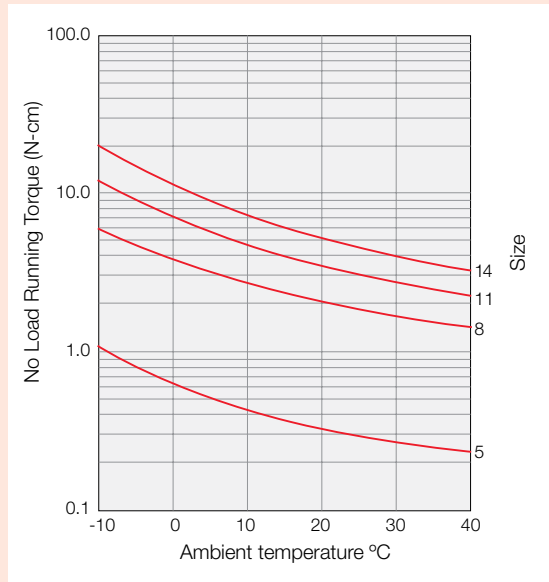

Input Speed 3500r/min

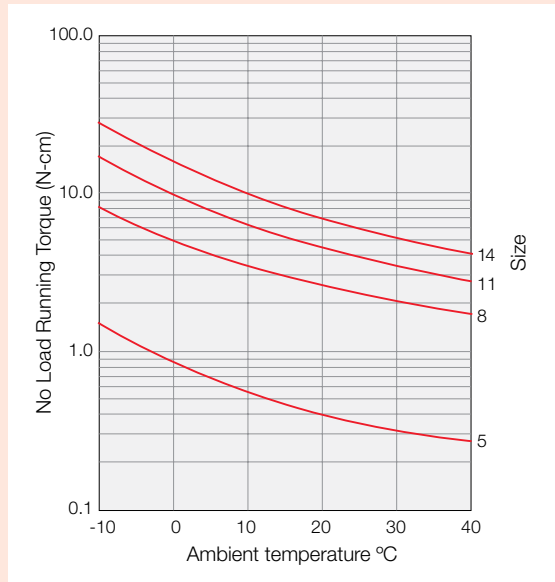

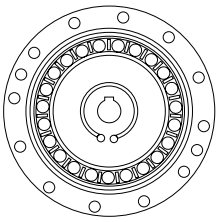

No Load Running Torque

Compensation Value in Each Ratio

No load running torque of the gear varies with ratio. The graphs indicate a value for ratio 100. For other gear ratios, add the compensation values from table at right.

Size	No load Running Torque Compensation Value			Ncm
	Ratio			
	30	50	80	
5	0.26	0.11	-	
8	0.44	0.19	-	
11	0.81	0.36	-	
14	1.33	0.58	0.1	

2XH

Input Speed 500r/min

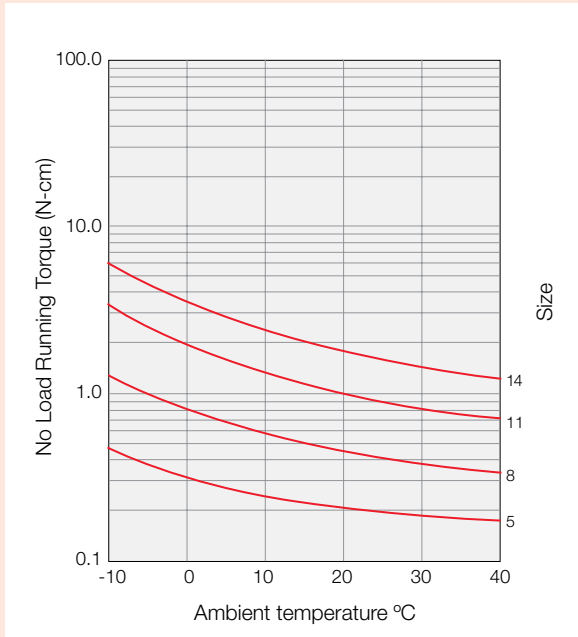

Input Speed 000r/min

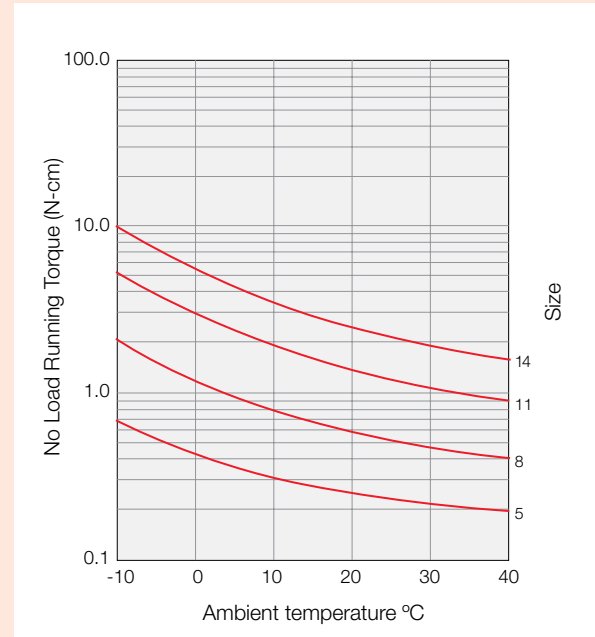

Input Speed 2000r/min

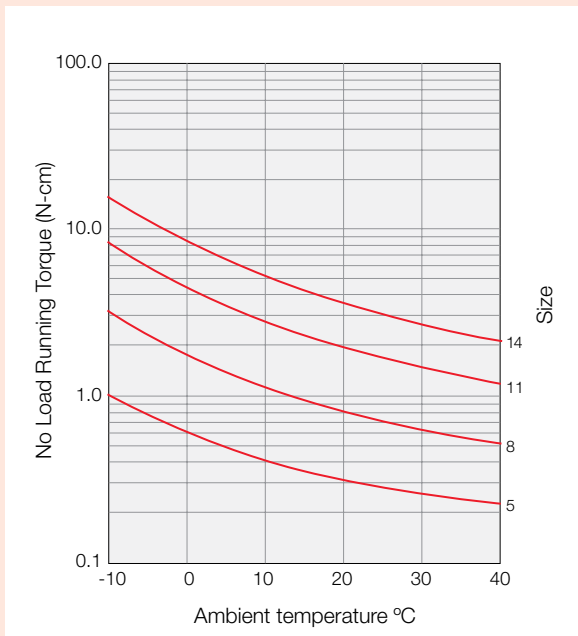

Input Speed 3500r/min

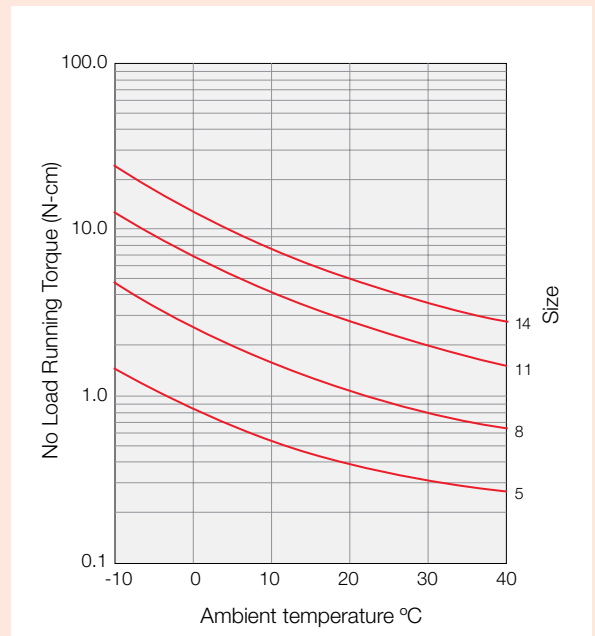

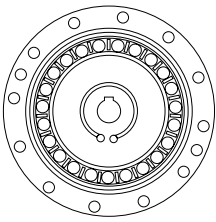

STARTING TORQUE AND BACKDRIVING TORQUE

Starting Torque

Starting torque is the torque required to commence rotation of the input element (high speed side), with no load being applied to the output. The table below indicates the maximum values. The lower values are approximately 1/2 to 1/3 of the maximum values. Temperature is at 20 degree C.

Starting Torque	Ratio				Ncm
	30	50	80	100	
Size					
5	0.53	0.40	-		0.30
8	1.3	0.80	-		0.59
11	3.4	2.0	-		1.5
14	6.4	4.1	2.8		2.5

Positioning Accuracy

The positioning accuracy of the gear represents a linearity error between the input and output angle. The position error is the difference between theoretical and actual output rotation angle.

The positioning accuracy is measured for one complete output revolution using a high resolution measurement system. The measurements are carried out without reversing direction.

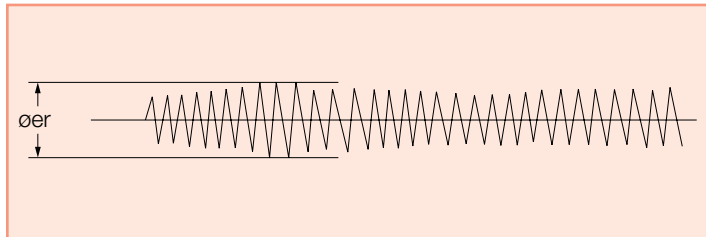

Component Type Backdriving Torque

Backdriving torque is the torque required to commence rotation of input element (high speed side) when torque is applied on the output side (low speed side). The table below indicates the maximum values. The typical values are approximately 1/2 to 1/3 of the maximum values. The backdriving torque should not be relied upon to provide a holding torque to prevent the output from backdriving. A failsafe brake should be used for this purpose.

Measurement condition: Ambient temperature 20°C

Values shown below vary depending on condition. Please use values as a reference.

θ_{er}Positioning Accuracy
 θ_1Input Angle
 θ_2Actual Output Angle
 RGear Ratio (i=1;R)

$$\theta_{er} = \theta_2 - \frac{\theta_1}{R}$$
 equation [18]

Positioning Accuracy	Size				arc-min
	5	8	11	14	
Ratio					
30	4	2	2		2
50+	3	2	1.5		1.5

Back Driving Torque	Ratio				Nm
	30	50	80	100	
Size					
5	0.29	0.21	-		0.27
8	0.70	0.55	-		0.75
11	1.7	1.2	-		1.5
14	2.4	1.6	1.6		1.8

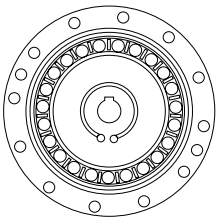

TORSIONAL STIFFNESS

Torsional Stiffness

Torsional stiffness is determined by applying a load to the output of the gear, with the input rotationally locked. The angular rotation is measured as the load is increased. The typical curve (shown in the figure 11) is non-linear. The stiffness is determined the slope of this curve. For simplicity, the curve is approximated by 3 straight lines having stiffness of K₁, K₂, and K₃. Stiffness K₁ applies for output torque of 0 to T₁. Stiffness K₃ applies for output torque greater than T₂. Stiffness K₂ applies for output torque between T₁ and T₂. Typical stiffness values are shown in tables 14, 15, 16.

Figure 8

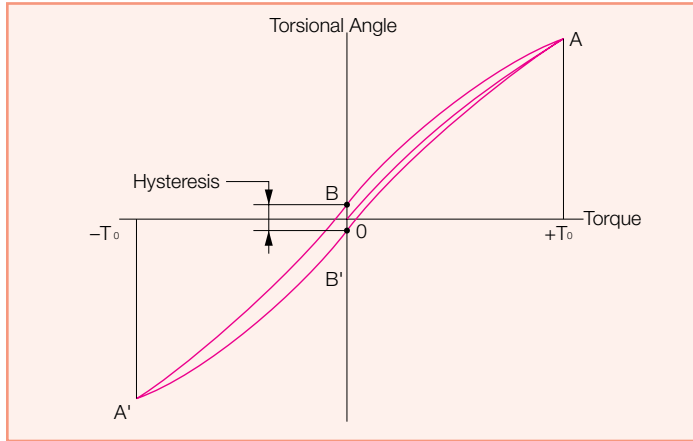
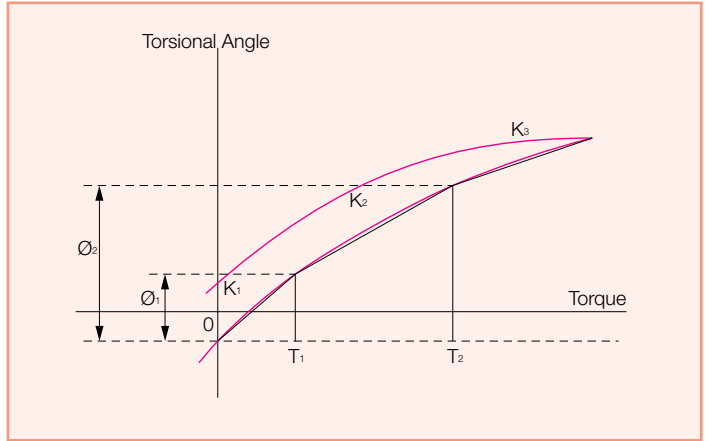

Figure 9



Torsional Stiffness for Ratio 1/30

Table 14

Size		5			8			11			14		
Model		2XH-F	2XH-J	1U	2XH-F	2XH-J	1U	2XH-F	2XH-J	1U	2XH-F	2XH-J	1U
T ₁	Nm	0.075			0.29			0.80			2.0		
	In-lb	0.66			2.57			7.08			17.70		
K ₁	X 10 ⁴ Nm/rad	0.010	0.009	0.009	0.034	0.031	0.031	0.084	0.077	0.077	0.188	0.172	0.172
	In-lb/arc-min	0.258	0.232	0.232	0.876	0.798	0.798	2.163	1.983	1.983	4.841	4.429	4.429
Q ₁	X 10 ⁻⁴ rad	7.5	8.7	8.7	8.6	9.5	9.5	9.5	10	10	11	12	12
	arc-min	2.6	3.0	3.0	3.0	3.2	3.2	3.3	3.6	3.6	3.6	4.0	4.0
T ₂	Nm	0.22			0.75			2.0			6.9		
	In-lb	1.95			6.64			17.70			61.07		
K ₂	X 10 ⁴ Nm/rad	0.013	0.011	0.011	0.044	0.039	0.039	0.124	0.109	0.109	0.235	0.210	0.210
	In-lb/arc-min	0.335	0.283	0.283	1.133	1.004	1.004	3.193	2.807	2.807	6.051	5.408	5.408
Q ₂	X 10 ⁻⁴ rad	19	22	22	19	21	21	19	21	21	31	35	35
	arc-min	6.4	7.5	7.5	6.6	7.3	7.3	6.6	7.4	7.4	11	12	12
K ₃	X 10 ⁴ Nm/rad	0.016	0.012	0.012	0.054	0.046	0.046	0.158	0.134	0.134	0.335	0.286	0.286
	In-lb/arc-min	0.412	0.309	0.309	1.391	1.185	1.185	4.069	3.451	3.451	8.626	7.365	7.365

Torsional Stiffness for Ratio 1/50

Table 15

Size		5			8			11			14		
Model		2XH-F	2XH-J	1U	2XH-F	2XH-J	1U	2XH-F	2XH-J	1U	2XH-F	2XH-J	1U
T ₁	Nm	0.075			0.29			0.80			2.0		
	In-lb	0.66			2.57			7.08			17.70		
K ₁	X 10 ⁴ Nm/rad	0.013	0.011	0.011	0.044	0.039	0.039	0.221	0.177	0.177	0.335	0.286	0.286
	In-lb/arc-min	0.335	0.283	0.283	1.133	1.004	1.004	5.691	4.558	4.588	8.626	7.365	7.365
Q ₁	X 10 ⁻⁴ rad	5.6	6.9	6.9	6.6	7.5	7.5	3.6	4.5	4.5	6.0	7.0	7.0
	arc-min	2.0	2.4	2.4	2.3	2.6	2.6	1.2	1.6	1.6	2.0	2.4	2.4
T ₂	Nm	0.22			0.75			2.0			6.9		
	In-lb	1.95			6.64			17.70			61.07		
K ₂	X 10 ⁴ Nm/rad	0.018	0.014	0.014	0.067	0.056	0.056	0.300	0.225	0.225	0.468	0.378	0.378
	In-lb/arc-min	0.464	0.361	0.361	1.725	1.442	1.442	7.725	5.794	5.794	12.051	9.734	9.734
Q ₂	X 10 ⁻⁴ rad	14	18	18	14	16	16	7.6	9.9	9.9	16	20	20
	arc-min	4.8	6.0	6.0	4.7	5.4	5.4	2.6	3.4	3.4	5.6	6.8	6.8
K ₃	X 10 ⁴ Nm/rad	0.025	0.017	0.017	0.084	0.067	0.067	0.320	0.236	0.236	0.568	0.440	0.440
	In-lb/arc-min	0.644	0.438	0.438	2.163	1.725	1.725	8.240	6.077	6.077	14.626	11.330	11.330

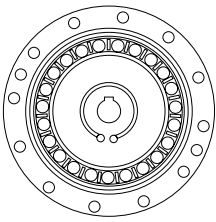

TORSIONAL STIFFNESS

Torsional Stiffness for Ratio 1/80

Table 16

Size		5			8			11			14		
Model		2XH-F	2XH-J	1U	2XH-F	2XH-J	1U	2XH-F	2XH-J	1U	2XH-F	2XH-J	1U
T ₁	Nm	0.075			0.29			0.80			2.0		
	In-lb	0.66			2.57			7.08			17.70		
K ₁	X 10 ⁴ Nm/rad	0.020	0.015	0.015	0.09	0.072	0.072	0.267	0.206	0.206	0.468	0.378	0.378
	In-lb/arc-min	0.515	0.386	0.386	2.318	1.854	1.854	6.875	5.305	5.305	12.051	9.734	9.734
Q ₁	X 10 ⁻⁴ rad	3.7	5.0	5.0	3.2	4.1	4.1	3.0	3.9	3.9	4.3	5.3	5.3
	arc-min	1.3	1.7	1.7	1.1	1.4	1.4	1.0	1.3	1.3	1.5	1.8	1.8
T ₂	Nm	0.22			0.75			2			6.9		
	In-lb	1.95			6.64			17.70			61.07		
K ₂	X 10 ⁴ Nm/rad	0.027	0.018	0.018	0.104	0.08	0.08	0.333	0.243	0.243	0.601	0.46	0.46
	In-lb/arc-min	0.695	0.464	0.464	2.678	2.060	2.060	8.575	6.257	6.257	15.476	11.845	11.845
Q ₂	X 10 ⁻⁴ rad	9.2	13	13	7.7	9.8	9.8	6.6	8.8	8.8	12	16	16
	arc-min	3.1	4.4	4.4	2.6	3.4	3.4	2.3	3.0	3.0	4.2	5.4	5.4
K ₃	X 10 ⁴ Nm/rad	0.030	0.020	0.020	0.120	0.089	0.089	0.432	0.291	0.291	0.700	0.516	0.516
	In-lb/arc-min	0.773	0.515	0.515	3.090	2.292	2.292	11.124	7.493	7.493	18.025	13.287	13.287

Hysteresis Loss

A typical hysteresis curve is shown in figure 8. With the input locked, a torque is applied from 0 to ± Rated Torque. Hysteresis measurement is shown in the figure.

The following table shows typical hysteresis values.

Calculate Torsion Angle

- For $T < T_1$: $Q = T/K_1$
- For $T_1 < T < T_2$: $Q = T_1/K_1 + (T - T_1)/K_2$
- For $T_2 < T$: $Q = T_1/K_1 + (T_2 - T_1)/K_2 + (T - T_2)/K_3$

Note: Units for T, T₁, T₂, K₁, K₂, K₃, and Q must be consistent.

- T₁₁ = 0.5Nm (T < T₁)

$$\begin{aligned}
 Q_{11} &= T_{11}K_1 \\
 &= 0.50/0.286 \times 10^4 \\
 &= 1.75 \times 10^4 \text{ rad (0.6 arc min)}
 \end{aligned}$$

- T₁₂ = 4Nm (T₁ < T < T₂)

$$\begin{aligned}
 Q_{12} &= Q_{11} + (T_{12} - T_1)K_2 \\
 &= 7.0 \times 10^4 + (4 - 2)/0.378 \times 10^4 \\
 &= 12.3 \times 10^4 \text{ rad (4.2 arc min)}
 \end{aligned}$$

*Note: Units for T, T₁, T₂, K₁, K₂, K₃, and Q must be consistent.

Backlash from Oldham Coupling

The gear element has zero backlash. However, an Oldham coupling is included as standard with all gearing components and gearheads. The Oldham coupling compensates for motor shaft concentricity errors. Unfortunately, the Oldham coupling does add a small amount of backlash to the system. Backlash values are shown in table 18. This amount of backlash is usually negligible. Component sets and gearheads can be supplied without an Oldham coupling. This is called a "Direct Drive" version.

Surface Treatment

Corrosion resistant surface treatments are available for exposed areas of the gear. Additionally some components can be manufactured using corrosion resistant steels.

Table 17 Hysteresis Loss

Ratio		Size			
		5	8	11	14
30	X10 ⁻⁴ rad	8.7	8.7	8.7	8.7
	arc-min	3	3	3	3
50	X10 ⁻⁴ rad	8.7	5.8	5.8	2.9
	arc-min	3	2	2	1
80 and up	X10 ⁻⁴ rad	8.7	5.8	5.8	2.9
	arc-min	3	2	2	1

Table 18 Maximum Backlash

Ratio		Size		
		8	11	14
30	X10 ⁻⁵ rad	28.6	23.8	29.1
	arc-sec	59	49	60
50	X10 ⁻⁵ rad	17	14.1	17.5
	arc-sec	35	24	36
80	X10 ⁻⁵ rad	-	-	11.2
	arc-sec	-	-	23
100	X10 ⁻⁵ rad	8.7	7.3	8.7
	arc-sec	18	15	18

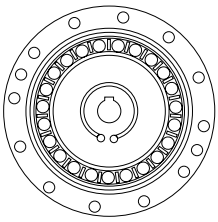

RECOMMENDED TOLERANCES FOR ASSEMBLY

Recommended Tolerances for Assembly

For peak performance of the CSF-min, Gearhead Type 2XH it is essential that the following tolerances be observed when assembly is complete.

Recommended Tolerances for Assembly

Figure 10

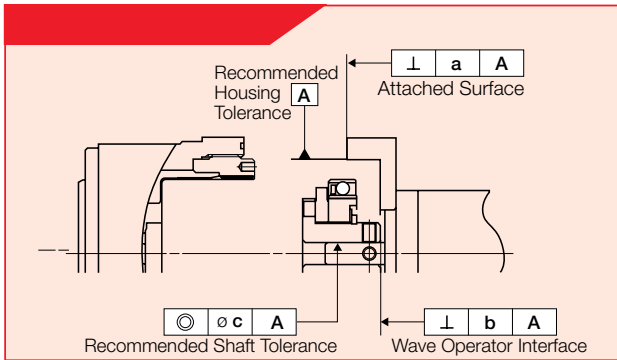
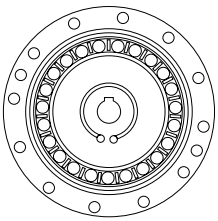

Table 19 Recommended Tolerances for Assembly

Nm

Symbol		Size			
		5	8	11	14
a	Attached Surface	0.008	0.010	0.011	0.011
b	Wave Generator Interface	0.005	0.012 (0.006)	0.012 (0.007)	0.017 (0.008)
c	Concentricity	0.005	0.015 (0.006)	0.015 (0.007)	0.030 (0.016)

* The values in parenthesis indicate that the wave generator does not have an Oldham coupling.



AXIAL FORCE

Figure 11

Direction for Thrust Force of Wave Generator

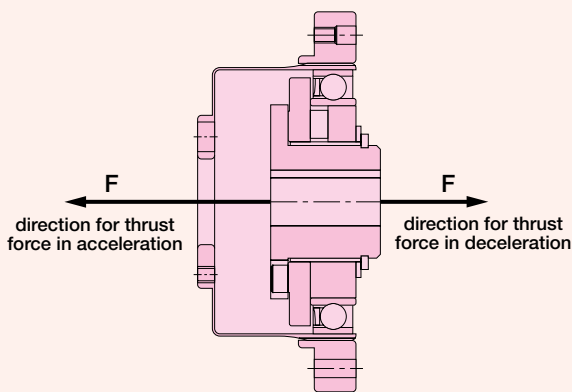

Equation for axial force

Gear Ratio	equation
$i=1/30$	$F=2x \frac{T}{D} x 0.07 x \tan 32^\circ$
$i=1/50$	$F=2x \frac{T}{D} x 0.07 x \tan 30^\circ$
$i=1/80$ and up	$F=2x \frac{T}{D} x 0.07 x \tan 20^\circ$

Symbols for equation

F	axial force	N
D	Gear Size x 0.00254	m
T	output torque	Nm

Axial Force of Wave Generator

When a CSF gear is used to accelerate a load, the deflection of the Flexspline leads to an axial force acting on the Wave Generator. This axial force, which acts in the direction of the closed end of the Flexspline, must be supported by the bearings of the input shaft (motor shaft).

When a CSF gear is used to decelerate a load, an axial force acts to push the Wave Generator out of the Flexspline cup. Maximum axial force of the Wave Generator can be calculated by the equation shown below. The axial force may vary depending on its operating condition. The value of axial force tends to be a larger number when using high torque, extreme low speed and constant operation. The force is calculated (approximately) by the equation. In all cases, the Wave Generator must be axially (in both directions), as well as torsionally, fixed to the input shaft.

Note: Please contact us when you fix the Wave Generator hub and input shaft using bolts.

Calculation Example

size	:	11
Ratio	:	$i=1/50$
Output Torque	:	3.5 Nm
$F=2x \frac{3.5}{(11x0.00254)} x 0.07 x \tan 30^\circ$		
$F=10N$		

Sealing structure

A seal structure is needed to maintain the high durability of gearing and prevent grease leakage.

Key Points to Verify

- Rotating parts should have an oil seal (with spring), surface should be smooth (no scratches)
- Mating flanges should have an O Ring, seal adhesive
- Screws should have a thread lock (Loctite 242 recommended) or seal adhesive.

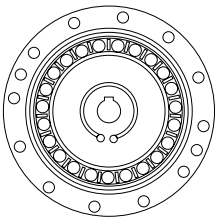

PERFORMANCE DATA FOR INPUT BEARING

Performance Data for the Input Bearing

The Input Shaft incorporated in the CSF-1U unit is supported by two deep groove single row ball bearings. Please calculate Input load to fully maximize the performance of CSF-1U gearhead.

Fig.12 shows the points of application of forces, which determine the maximum permissible radial and axial loads as indicated in Fig.13.

The maximum values, as given in Figures 13, are valid for an average input speed of 2000 rpm and a mean bearing life of $L_{10}=7000h$.

Example: If the input shaft of a CSF-14-1U unit is subjected to an axial load (F_a) of 8N, then the maximum permissible radial face will be 20N, Fig. 13.

Specification for Input Bearing

Table 20

Size	Bearing A	Bearing A				Bearing B Bearing B0-	Bearing B				b (mm)	(mm)	(N)	lb
		Basic Dynamic Rated Load Cr (N)	lb	Basic Static Rated Load Cor (N)	lb		Basic Dynamic Rated Load Cr (N)	lb	Basic Static Rated Load Cor (N)	lb				
5	SSLF-630DD	196	44	59	13	L-520W02	176	40	54	12	10.8	9.25	8	2
8	MR126	715	161	292	66	MR83	560	126	170	38	16.65	18	10	2
11	689	1330	299	665	149	624	1300	292	485	109	20.6	21.9	20	4
14	6900ZZ	2700	607	1270	285	605ZZ	1330	299	505	114	28.25	24.25	30	7

Point of Shaft

Figure 12

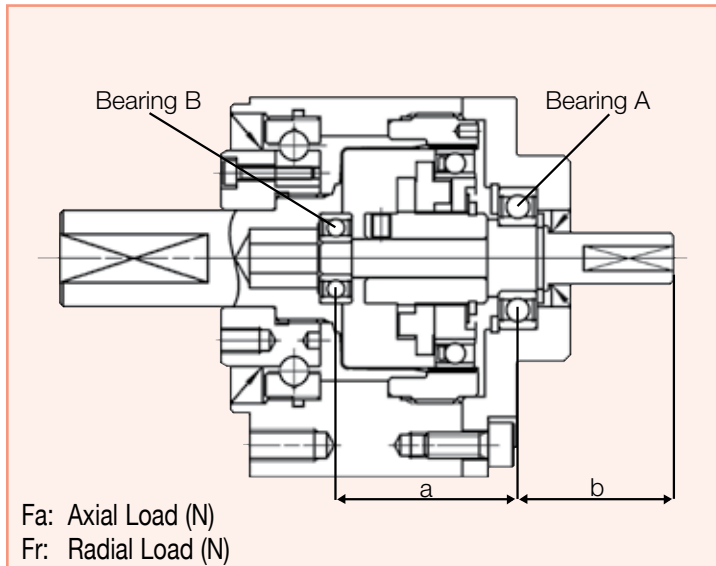
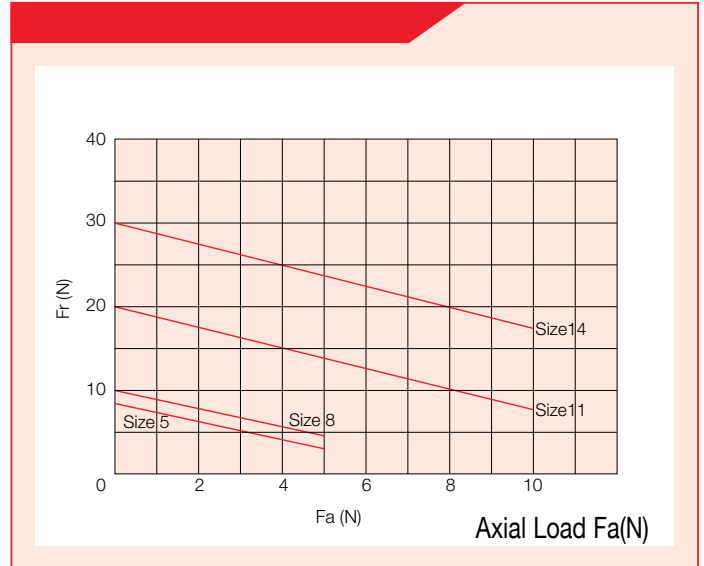
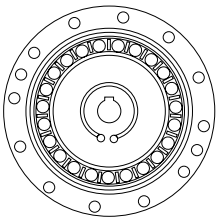

Figure 13





INSTALLATION OF CASE SIDE

Ensure that surface used for installation is flat and does not have any burr.
Please fasten bolt with the proper torque for each size as indicated.

1U

Table 21

Size	5		8		11		14	
Number of Bolts	4		4		4		4	
Size of Bolt	M2		M3		M4		M5	
Pitch Circle Diameter	mm	23	35	46	58			
Clamp Torque	Nm	0.25	0.85	2	3.96			
	In.lb	0.03	0.09	17.70	35.05			
Length of Bolt	mm	2.4	3.6	4.8	60			
Torque Transmission Capacity	Nm	3.5	12	29	57			
	In.lb	31	106	257	504			

Recommended Bolt: JISB1176 socket head cap, screw strength range: JISB1051 over 12.9

2XH

Table 22

Size	5		8		11		14	
Number of Bolts	2		2		2		2	
Size of Bolt	M2		M3		M4		M5	
Pitch Circle Diameter	mm	25	37.5	50	62			
Clamp torque	Nm	0.25	0.85	2	4			
	In.lb	2.21	7.52	17.70	35.40			
Length of Bolt	mm	2.4	3.6	4.8	6			
Torque Transmission Capacity	Nm	2	7	16	31			
	In.lb	18	62	142	274			

Recommended Bolt: JISB1176 socket head cap, screw strength range: JISB1051 over 12.9

Installation of Output Flange Please refer to "Specification for a Cross Roller Bearing". page 12-14

2XH (Output Flange)

Table 23

Size	5		8		11		14	
Number of Bolts	3		4		6		6	
Size of Bolt	M2		M3		M3		M4	
Pitch Circle Diameter	mm	9.8	15.5	20.5	25.5			
Clamp torque	Nm	0.54	2	2	4.6			
	In.lb	4.8	17.7	17.7	40.7			
Torque Transmission Capacity	Nm	2	13	26	55			
	In.lb	18	115	230	487			

***Output Flange is prevented for grease leakage, re-sealing is not necessary.

1U, 2XH-J (Output Shaft)

Avoid impact to output shaft during assembly of pulley or pinion, loss of accuracy and speed may occur.

Figure 14

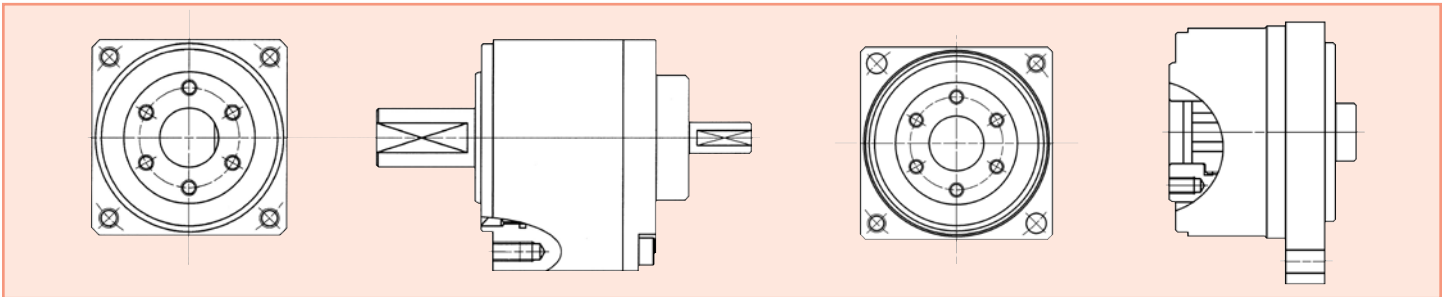

Lubrication

Harmonic Drive™ CSF-mini series are delivered ready for use. They are supplied with lifetime lubricant, which is high performance grease that meets the specific requirements of the gears. It guarantees constant accuracy of the gears over their entire service life.

Recommended Grease

Lubricant	Speed reducers	Cross Roller Bearing
Name of Lubricant	Harmonic Grease SK-2	Multemp HL-D
Manufacturer	Harmonic Drive Systems	Kyodo Yushi
Base Oil	Refined Mineral Hydrocarbon base oil	Hydrocarbon type synthetic oil and polymer
Thickening Agent	lithium soap thickener	Lithium soap thickener
Viscosity (25°)	295	280
Melting Point	198°C	210°C
Color	Green	White

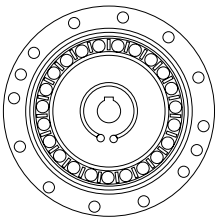

TOLERANCES FOR ASSEMBLY

Tolerances for Assembly

This innovative gearhead combines precision Harmonic Drive™ gear and a high capacity 4-point contact bearing for output flange/shaft support.

Recommended Tolerances for Assembly

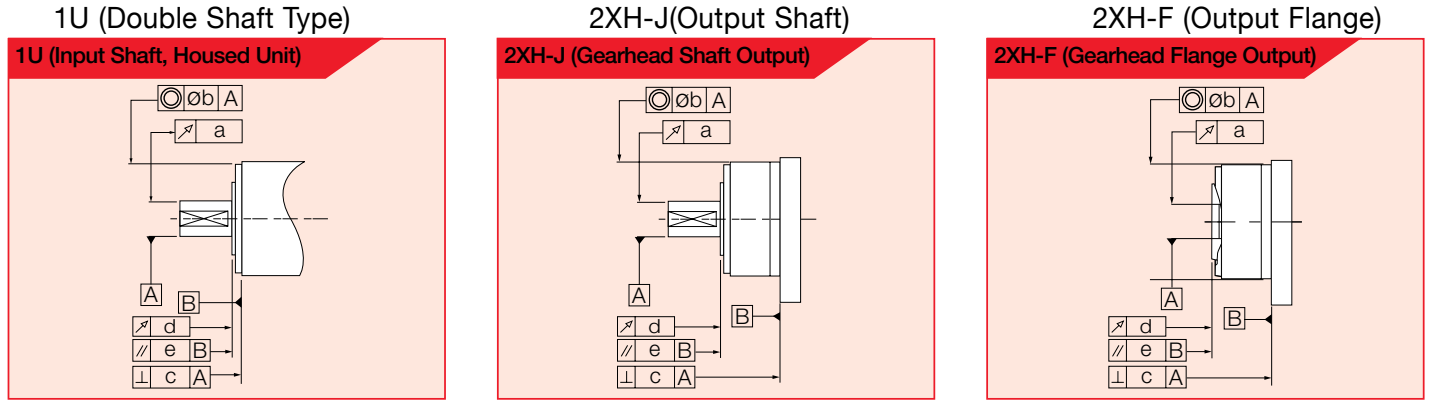

Torsional Stiffness for Ratio 1/80

Table 24

Size	Tolerances Item	Configuration							
		5		8		11		14	
		1U, 2XH-J	2XH-F	1U, 2XH-J	2XH-F	1U, 2XH-J	2XH-F	1U, 2XH-J	2XH-F
a	1U, 2XH-J Run Out 2XH-F Run Out	0.020	-	0.020	-	0.020	-	0.020	-
b	Concentricity	0.020	0.005	0.020	0.005	0.030	0.005	0.030	0.005
c	Perpendicularity	0.020	0.020	0.020	0.020	0.025	0.025	0.025	0.025
d	Run Out	0.005	0.005	0.005	0.005	0.005	0.005	0.005	0.005
e	Parallelism	0.015	0.020	0.020	0.020	0.030	0.030	0.030	0.030

Note:

Warranty Period and Terms

The Product is warranted as follows:

- Warranty period

Under the condition that the product is handled, used and maintained and conforms to each item of the documents and the manuals, the product is warranted against defects in workmanship and materials for the period of either one year after delivery or 2,000 hours of operation time, whichever is shorter.

- Warranty terms

All products are warranted against defects in workmanship and materials for the warranted period. This limited warranty does not apply to any product that has been subject to:

1. User's misapplication, improper installation, inadequate maintenance, or misuse.
2. Disassembling modification or repair by others than Harmonic Drive LLC.
3. Imperfection caused by something other than the product.
4. Disaster or other occurrences that does not belong to the responsibility of Harmonic Drive LLC.

Our liability shall be limited exclusively to repairing or replacing the product as found by Harmonic Drive LLC. to be defective. Harmonic Drive™ Systems, Inc. shall not be liable for consequential damages of other equipment caused by the defective product, and shall not be liable for the incidental and consequential expenses and the labor cost associated with disassembly and installation to the driven equipment.

- Trademark

The academic and general nomenclature for Harmonic Drive™ gear "Strain Wave Gearing". "Harmonic Drive" is a trademark that can be used only on products, which are manufactured and sold by Harmonic Drive LLC.

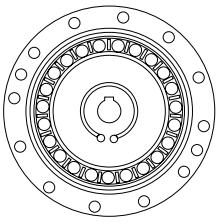

CSF-MINI

SAFETY GUIDE

- For actuators, motors, control units and drivers manufactured by Harmonic Drive LLC.
- Read the manual thoroughly before designing the application, installation, maintenance or inspection of the actuator.
- **WARNING:** Indicates a potentially hazardous situation, which, if not avoided, could result in death or serious personal injury.
- **CAUTION:** Indicates a potentially hazardous situation, which, if not avoided, may result in minor or moderate personal injury and/or damage to the equipment.

LIMITATION OF APPLICATIONS:

The equipment listed in this document may not be used for the following applications:

- Space equipment
- Aircraft, aeronautic equipment
- Nuclear equipment
- Household apparatus
- Vacuum equipment
- Automobile, automotive parts
- Amusement equipment, sport equipment, game machines
- Machine or devices acting directly on the human body
- Instruments or devices to transport or carry people
- Apparatus or devices used in special environments

Please consult us, if you intend to use our products in one of the areas mentioned above.

Safety measures are essential to prevent accidents resulting in death, injury or damage of the equipment due to malfunction or faulty operation.

Precautions When Using An Actuator and/or Driver

CAUTIONS FOR ACTUATORS IN APPLICATION DESIGN

The product must only be used indoors, where the following conditions are provided:

- Ambient temperature: 0°C to 40°C
- Ambient humidity: 20% to 80%RH (Non-condensating)
- Vibration: Max 24.5 m/S²
- No contamination by water, oil or foreign matters
- No corrosive, inflammable or explosive gas

Follow exactly the instructions in the relating manuals to install the product in the equipment.

- Ensure exact alignment of motor shaft center and corresponding center in the application.
- Failure to observe this caution may lead to vibration, resulting in damage of output elements.

CAUTIONS FOR ACTUATORS IN OPERATIONS

Do not exceed the allowable torque of the actuator.

- Be aware, that if a load arm attached to the output hits by accident an obstacle, the output shaft may become uncontrollable.

Never connect cables directly to a power supply socket.

- An actuator must not be operated without a corresponding driver.
- Failure to observe this caution may lead to injury, fire or damage of the actuator.

Protect the actuator from impact and shocks

- Do not use a hammer to position the actuator during installation
- Failure to observe this caution could damage the encoder and may cause uncontrollable operation.
- Avoid handling of the actuator by its cables.
- Failure to observe this caution may damage the wiring, causing uncontrollable or faulty operation.

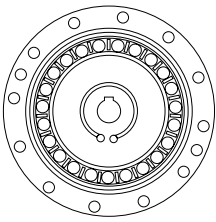

CAUTIONS FOR DRIVERS IN APPLICATION DESIGN

Always use drivers under the following conditions:

- Mount in a vertical position keeping sufficient distance to other devices to let heat generated by the driver radiate freely.
- Ambient temperature: 0° to 50°
- Ambient humidity: less than 95% RH (Non condensation)
- No contamination by water, oil or foreign matters
- No corrosive, inflammable or explosive gas Use sufficient noise suppressing means and safe grounding.
- Keep signal and power leads separated.
- Keep leads as short as possible.
- Ground actuator and driver at one single point, minimum ground resistance class: D (less than 100 ohms)
- Do not use a power line filter in the motor circuit. Pay attention to negative torque by inverse load.
–Inverse load may cause damages of drivers.
- Please consult our sales office, if you intent to apply products for inverse load. Use a fast-response type ground-fault detector designed for PWM inverters.
- Do not use a time-delay-type ground-fault detector.

CAUTIONS FOR DRIVERS IN OPERATIONS

Never change wiring while power is active:

- Make sure of power non-active before servicing the products.
- Failure to observe this caution may result in electric shock or personal injury.
Do not touch terminals or inspect products at least 5 minutes after turning OFF power.
- Otherwise residual electric charges may result in electric shock.
- Make installation of products not easy to touch their inner electric components. Do not make a voltage resistance test.
- Failure to observe this caution may result in damage of the control unit.
- Please consult our sales office, if you intent to make a voltage resistance test.
- Do not operate control units by means of power ON/OFF switching.
- Start/stop operation should be performed via input signals.
- Failure to observe this caution may result in deterioration of electronic parts.

DISPOSAL OF AN ACTUATOR, A MOTOR, A CONTROL UNIT AND/OR THEIR PARTS

- All products or parts have to be disposed of as industrial waste.
- Since the case or the box of drivers have a material indication, classify parts and dispose them separately.

All products are warranted to be free from design or manufacturing defects for a period of one year from the date of shipment. Such items will be repaired or replaced at the discretion of Harmonic Drive LLC. The seller makes no warranty, expressed or implied, concerning the material to be furnished other than it shall be of the quality and specifications stated. The seller's liability for any breach is limited to the purchase price of the product. All efforts have been made to assure that the information in this catalog is complete and accurate. However, Harmonic Drive LLC is not liable for any errors, omissions or inaccuracies in the reported data. Harmonic Drive LLC reserves the right to change the product specifications, for any reason, without prior notice.